

RCDT300 Series
Residual Current Device testers

USER MANUAL

**SAFETY WARNINGS**

- **Safety Warnings** and **Precautions** must be read and understood before the instrument is used. They **must** be observed during use.
- Continuity of protective conductors and earthed equipotential bonding of new or modified installations **must** be verified **before** carrying out RCD tests.
- Do not leave the instrument connected to the mains supply when not in use.
- Circuit connections and exposed metalwork of an installation or equipment under test must not be touched.
- Ensure that hands remain behind guards of probes/clips when testing.
- **Do not move** the rotary selector knob position while a test is in progress.
- The instrument should **not** be used if any part of it is damaged.
- Test leads, probes and crocodile clips **must** be in good order, clean and with no broken or cracked insulation.
- The battery cover must be in place whilst conducting tests.
- Voltage indicator LED's cannot reveal a N-PE supply reversal.

NOTE**THE INSTRUMENT MUST ONLY BE USED BY SUITABLY TRAINED AND COMPETENT PERSONS.**

Users of this equipment and/or their employers are reminded that Health and Safety Legislation requires them to carry out valid risk assessments of all electrical work so as to identify potential sources of electrical danger and risk of electrical injury such as inadvertent short circuits.

Some national safety authorities recommend fused leads for voltage measurement on high energy systems. If RCD or Loop tests are made it may cause the fuse to rupture, and so they must be used with caution on voltage testing.

CONTENTS

Safety warnings:	2
Introduction	4
General description	4
Un-packing the carton	5
LCD Display	6
Top panel	6
Lid open/closure	17
Preparations for use	8
Batteries	8
Preliminary test lead check	8
General operating instructions	8
Display warning symbols	9
Setup procedure	9
Reverse polarity detection	9
Touch voltage	10
Test Leads	10
Test lead connection.	10
LED indicators	11
Residual Current Device [RCD] testing	11
RCD type selection	12
ΔI RCD Non-tripping measurement	12
1xI & 5xI RCD trip time measurement	12
0 or 180° testing	12
RampTest 	12
DC Sensitive RCD test [RCD]	13
Voltage measurement	13
Frequency Hz (RCDT320 only)	14
Replacing batteries and fuses	14
Low battery warning symbol	14
To replace batteries	14
Fuse Blown indication	15

Preventive maintenance	15
Touch voltage enable/inhibit and Reverse polarity or line/neutral swapping	16
General Specification	17
Basic and service errors	18
Accessories and equipment	18
Repair and Warranty	19

Symbols used on the instrument are:



Caution: refer to accompanying notes



Equipment protected throughout by Double Insulation (Class II)



Equipment complies with current EU directives.



Equipment complies with 'C tick' requirements

INTRODUCTION

Thank you for purchasing the Megger RCD Tester.

For your own safety and to get the maximum benefit from your instrument, please ensure that you read and understand the following safety warnings and instructions before attempting to use the instruments.

This user manual describes the operation and functions of the following RCDT300 series of RCD testers:

RCDT310

RCDT320

GENERAL DESCRIPTION

The RCDT300 Series test instruments have the following features:

Feature	RCDT310	RCDT320
3 Phase safe	■	■
Display backlight		■
Battery status indication	■	■
Auto power down	■	■
Fuse blown indication	■	■
L-N-E polarity indicators	■	■
Voltmeter	■	■
Frequency measurement		■
Reverse polarity operation (can be disabled)	■	■
ΔI , I, 5I RCD trip time test	■	■
Auto sequence test	■	■
Fault voltage display (selectable)	■	■
Max touch voltage selectable (25/50 V)	■	■
Touch voltage display	■	■
RCD trip current test (RAMP)		■
0°/180° polarity selection	■	■
Selective breakers	■	■

UNPACKING THE CARTON

Feature	RCDT310	RCDT320
DC breakers (1/2 I, I, 5I)	■	■
30, 100, 300, 500 mA RCDs	■	■
10mA/1000mA RCD		■
Plug ended test lead	■	■
2 wire test lead probe/croc clip ended		■
Calibration Certificate	■	■
IEC61010-1 300V CATIII	■	■
EN61557	■	■

Unpack the carton contents carefully. There are important documents that you should keep for future reference.

Please complete the pre-paid warranty card and return it to Megger Limited as soon as possible to help us reduce any delays in supporting you should the need arise.

Carton contents RCDT310 and RCDT320:

- 1 x RCDT300 series RCD tester
- 1 x 3 wire test lead with prods with clips
- 8 x AA (LR6) batteries (fitted in instrument)
- 1 x Test lead case
- 1 x Warranty card
- 1 x Calibration certificate
- 1 x Owners CD manual
- 1 x Safety instructions

LCD DISPLAY

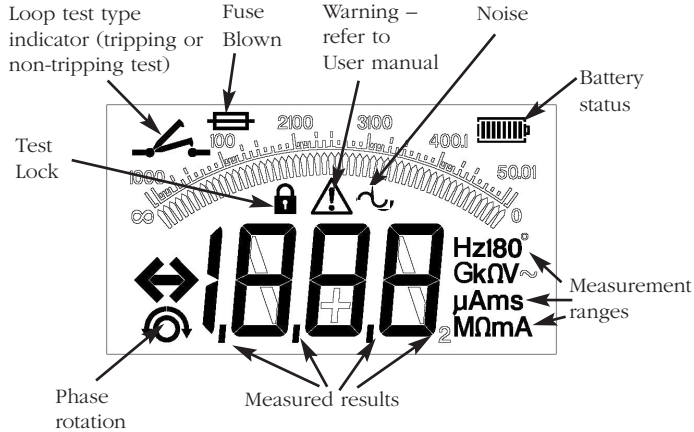

FRONT PANEL

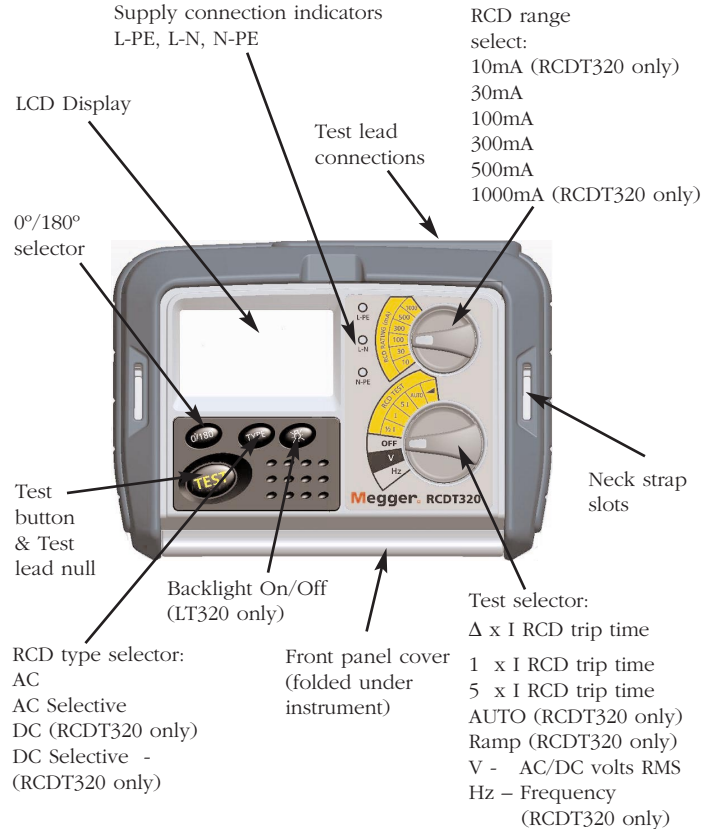

Connection Panel

RCDT300 Series test lead connections

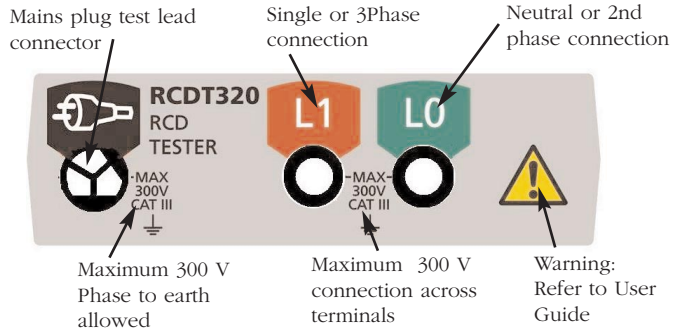

Lid open/closure

1. Open lid by lifting up front panel tab (1).
2. Fold-away underneath instrument (2 & 3) and push into retaining slot (4).

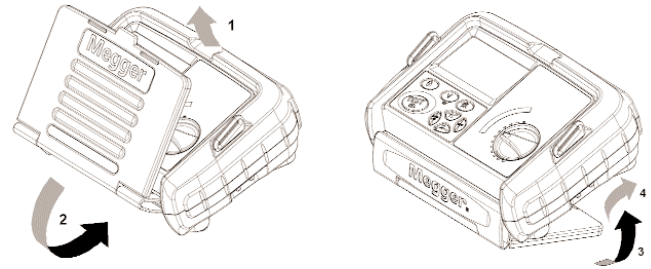

PREPARATIONS FOR USE (ALL INSTRUMENTS)

Batteries

The Megger RCDT300 series instruments are supplied with batteries fitted. When batteries become exhausted, refer to section 8, battery replacement.

Warning: Do not switch the instrument on with the battery cover removed.

Preliminary test lead check

Functional verification

Before each use of the instrument, visually inspect the test leads, prods and crocodile clips to confirm that their condition is good, with no damaged or broken insulation.

GENERAL OPERATING INSTRUCTIONS

Test inhibit

The following condition may cause the instrument to inhibit testing:

Out of range supply voltage

If an out of range voltage or frequency exists on the circuit under test, or on a very noisy mains supply, testing will be automatically inhibited.

Overheating

Repetitive RCD Ramp testing and some high current RCD trip testing generates heat within the instrument. If this heat becomes excessive the instrument will warn the operator and prevent further testing until the instrument has had a chance to cool down.

Fuse Blown

A fuse blown will prevent the instrument from making further tests. The fuse indicator will be displayed.

Default voltmeter

The default voltmeter automatically operates in all test modes, indicating connection to a live system.

Auto Power-down

To extend battery life the instrument will automatically switch off six minutes after the last operation.

It can be switched off manually by selecting [OFF] with the rotary switch, or switched back on again by pressing the [TEST] button.

Backlight operation (LT 320 only)

The RCDT320 LCD display may be backlit. The backlight function can be selected at any time while the instrument is switched on by pressing the BACKLIGHT  button.

The backlight function will switch off automatically 15 seconds after the instrument has finished testing.

Display warning symbols



Refer to user manual.

Any time the warning triangle is displayed the operator should refer to the user manual for further information.



Range lock

Displayed at any time the [TEST] button is locked in the on position.



Battery condition indication. Refer to page 16.



Fuse blown indicator, appears when an instrument fuse has failed.
Refer to page 16.

>280V Displayed on the RCDT310 indicates a supply voltage in excess of the allowed is present.

hot Indicates the instrument needs to cool down before it can continue loop testing

Setup Procedure

Note: Line reversal and RCD touch voltage configuration features are only available on the instruments as per the relevant tables in the specification section of this document.

Reverse polarity detection / Touch voltage setting

To select Polarity reversal acceptance or rejection:

1. With the instrument switched OFF, hold down the [TEST] button and turn the range knob to any ON position.
2. Keep the button held down until the instrument displays the 'SET' warning.
3. Now release the [TEST] button.
4. Press the [TEST] button again to view the current setting for line/neutral swapping.
5. The display shows 'L+L' (instrument will perform tests with L & N swapped) or 'L+N' (instrument will not perform tests with L & N swapped).
6. Press the [LOCK] button or the PFC button to change the setting.
7. Press the [TEST] button to exit from the set-up menu.

RCD Touch voltage selection

To set the touch voltage inhibit limit:

1. With the instrument switched OFF, hold down the [TEST] button and turn the range knob to any ON position.
2. Keep the button held down until the instrument displays the 'SET' warning.
3. Now release the [TEST] button.
4. Press the [TEST] button twice to view the current settings for the touch voltage.

- The display shows the fault voltage limit, '25 V' or '50 V'.
 If the fault-voltage display is active, a bar-graph display will also appear.
5. Press the [0°/180°] button to change the limit setting from 25V to 50V and back.
 6. Press the [TYPE] button to turn bar-graph display ON or OFF.
 7. Press the [TEST] button to exit from the set-up menu.

Test leads

All test leads form part of the measuring circuit of the instrument and must not be modified or changed in any way, or be used with any other electrical instrument or appliance.

The power cord supplied with the Megger testers is a test lead that forms part of the measuring circuit of the instrument. The overall length of this lead must not be altered. If the power cord plug is not suitable for your type of socket outlets, do not use an adapter. You may change the plug once only by cutting the cord as close to the plug as possible and fitting a suitable plug.

The colour code of the cord is:

Earth (Ground) Yellow/Green

Neutral Blue

Phase (Line) Brown

NOTE: A plug severed from the power cord must be destroyed, as a plug with bare conductors is hazardous in a live socket outlet.

Test lead connection

The supplied test leads should be connected to the appropriate sockets on the rear of the instrument marked L0 and L1, or to the 3 way test socket.

Standard test probes and crocodile clips are supplied for connection to the circuit under test.

Application

This instrument may be connected live to earth or between live conductors of systems that have a rated voltage of 600 V a.c. rms to earth and an installation (overvoltage) Category III or lower.

This means that the instrument may be connected to any fixed wiring of a building installation, but not to primary supply circuits such as overhead cables. To maintain user safety and ensure accurate measurements, only use the test leads supplied by Megger Limited.

System Diagram - Where To Use Each Test

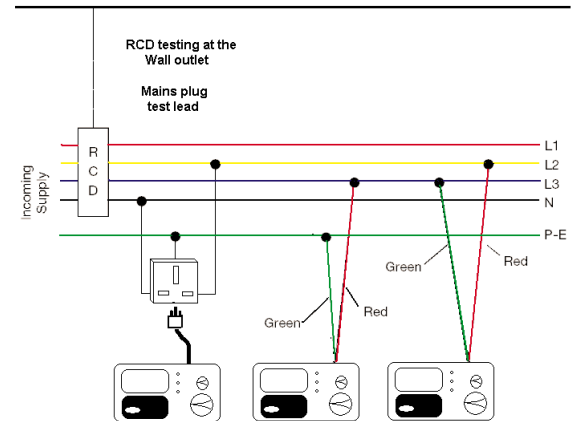







RESIDUAL CURRENT DEVICE [RCD] TESTING

LED indicators

Three RED led indicators show circuit connection status when correctly connected to a live circuit. These are for indication purposes only and should not be relied upon as a indication of the presence of a hazardous voltage.

When connected to the circuit to be tested the three status LED's will show the following supply connection information:

LED Indicator	Normal Supply	Reversed (L-N) supply	Notes
L - PE			Voltage between L- PE greater than 25 V
L - N			Voltage between L-N greater than 25 V
N - PE			Voltage between N-PE greater than 25 V

Warning: Voltage indicator LED's cannot reveal a N-PE supply reversal

Polarity Indication

If connected to a single phase power supply by a plug or by the 3-wire lead set, three LED's marked L-PE, N-PE and L-N respectively will indicate supply polarity

NOTE: The presence of a voltage between phase and earth does not prove earth continuity, as the earth could have a high resistance and a voltage would still be measured. To test earth continuity refers to the sections on loop testing.

Method of measurement

The plug ended test lead or two wire lead should be used for this measurement. A constant current source is connected across the supply and the time taken for the supply to trip is measured by the instrument in milliseconds (ms).

The RCDT310 and RCDT320 can perform the following RCD tests:

- | | |
|------------------|---|
| Type | The RCD type is selectable from, AC, AC Selective, DC, DC Selective, depending on instrument. |
| 1/2I | Non-tripping test at half the rated RCD trip current for 2 seconds, during which the RCD should not trip. |
| I | Tripping test at the rated RCD trip current started on zero crossing of the positive half cycle. The trip time will be displayed |
| 5I | Tripping test at 5 x the rated RCD trip current. The trip time will be displayed in milliseconds. |
| 0 or 180° | Some RCDs are sensitive to the polarity of the supply, i.e whether the test current is applied on the instantaneous rising or falling part of the supply cycle. Tests should therefore be performed at 0° and 180° and the maximum time recorded. |

Additionally the RCDT320 can perform the following tests:

- | | |
|-----------------|--|
| AUTO | Automatically steps through each RCD test (including 0 or 180°) whilst the operator stands by the RCD to reset it. |
| RampTest | Used to check the trip current of an RCD. |

RCD type selection

To select the RCD type to be tested:

1. Set the top RCD selection knob (top knob) to the desired RCD current range.
2. Set the RCD test knob to 1/2I, I or 5I as required.
3. Press the [TYPE] button to select the type of RCD under test:

Options are:

- AC Standard
- AC Selective
- DC Sensitive
- DC Selective

ΔI RCD (Non-tripping) measurement

To test the tripping time of the installed RCD under test:

Range selection:

1. Connect the mains plug test lead or 2-wire Red/Green test lead to the instrument.
2. Plug in the mains plug test lead to the wall outlet, or the 2 wire test lead across the RCD (refer to connection drawing in section 4.2)
3. Set the top RCD selection knob to the correct range for the RCD under test.
4. Set the bottom range knob to [1/2I]. The RCD trip indicator should display a closed symbol .
5. Ensure the display shows the mains voltage.
6. Press the [TEST] button. The instrument should display >1999ms and the RCD should NOT trip.

NOTE: If the RCD should trip while performing a 1/2I test the error message ‘**trP**’ will be displayed instead of the time display.

1xI RCD trip time measurement

To test the [1xI] trip time of the installed RCD:

1. Repeat the previous test for ΔI , but with the bottom range knob set to
1. The RCD trip indicator should display an open symbol .
2. The instrument should display the RCD trip time in milliseconds.

If the display shows >200 ms the RCD has failed to trip in the appropriate time. Check your test lead connections to the RCD and repeat the test.

If the RCD still fails to trip, suspect a faulty RCD.

Note: See also 0°/180° testing below.

0° or 180° testing

Both the [1 x I] and [5 x I] tests should be performed for 0° and 180°.

Repeat the 1 x I and 5 x I tests as above but with the instrument set to 180°.

0° or 180° is selected by pressing the [0°/180°] and the greatest trip time for each test recorded.

RampTest

The RCD trip current is measured by applying a test current of half the rated trip current and increasing this every 200ms. When the RCD trips, the current flowing is recorded and displayed in mA.

1. Select the appropriate RCD rated current on the top range knob.
2. Select the RAMP  test on the lower range knob.
3. Press the [TEST] test button
4. The RCD should trip and the trip current will be displayed.
5. If the RCD fails to trip, >***mA is displayed and the contact symbol will remain in the closed position, where *** mA indicates the maximum RCD tripping current allowed and will vary depending on range selected.

DC Sensitive RCD test [RCD]

D.C. sensitive RCDs are tested as per standard RCDs. The RMS current used is $\sqrt{2}$ x the rated operating current of the RCD.

As with the normal RCDs, these should be tested at 0° and 180°, or in the case of DC sensitive RCD's, positive or negative.

Possible sources of error

Measurement results can be affected by the following:

1. Significant operating errors can occur if loads, particularly rotating machinery and capacitive loads are left connected during tests.
2. A poor connection to the circuit under test.

NOTE: Measured voltage should not exceed 300V phase to earth.

To measure the voltage of the electrical supply:

1. Set the instrument to the [V] range.
2. Connect the GREEN OR (L0) lead to the protective Earth (PE) and the RED or (L1) lead to the phase to be measured. (Alternatively connect the mains plug test lead to a suitable mains outlet).
3. The instrument will display the Phase to Earth voltage.



To measure the frequency of the electrical supply:

1. Set the instrument to the [Hz] range.
2. Connect the GREEN or (L0) lead to the protective Earth (PE) and the RED or (L1) lead to the phase to be measured.
3. The instrument will display the frequency in Hz.

Batteries

Battery type: 8 x LR6 (AA), 1.5 V Alkaline, or 8 x 1.2V NiCAD, or 8 x 1.2V NiMH

Low battery warning symbol

The battery condition is continuously displayed by the symbol . When the batteries are exhausted, symbol will show  and testing is inhibited.

If symbol appears with new batteries, check for correct polarity.

NOTE: Fully charged NiMH or NiCAD rechargeable batteries show a lower charge than Alkaline batteries, and may not give much warning before becoming exhausted.

To replace batteries

Warning: Do not switch the instrument on with the battery cover removed.

1. Switch off the instrument and disconnect (the instrument) from any electrical circuits.
2. The rear cover **must not** be opened if the test leads are connected.
3. To avoid the possibility of electric shock, do not press the test button or touch the fuse when changing batteries.
4. To remove the rear cover release the screw at the bottom of the cover and lift the cover upwards.
5. Remove the dead cells.
6. Refit new batteries observing the correct polarity as marked on the battery compartment.
7. Replace the cover.

Warning: - Incorrect battery cell polarity can cause electrolyte leakage, resulting in damage to the instrument. If the battery condition indicator

PREVENTATIVE MAINTENANCE

does not show a full charge, a cell may be reversed.

NOTE: Battery cells should not be left in an instrument, which may remain unused for extended periods.

Fuse Blown indication

The fuse blown symbol  indicates that an internal fuse has failed. This instrument is fitted with a factory fitted fuse and should only be replaced by an authorised Megger repairer.

Contact your Megger distributor
or call Megger Limited on 01304 502 102.

Clean only with a damp cloth. Do not use any alcohol based cleaning fluids as they may leave a residue.

TOUCH VOLTAGE DISPLAY AND REVERSE POLARITY OR LINE/NEUTRAL SWAPPING

This table indicates which Megger RCD300 series testers feature the Touch voltage inhibit feature:

RCD Testers	Line reversal detection	Inhibit available	RCD Testers	Line reversal detection	Inhibit available
				Y/N	Y/N
English language			Swedish language		
RCDT310-EN-AU	No	No	RCDT310-SE-SC	No	No
RCDT320-EN-AU	No	No	RCDT320-SE-SC	No	No
RCDT310-EN-BS	No	No	Dutch language		
RCDT320-EN-BS	No	No	RCDT310-NL-SC	No	No
RCDT310-EN-SC	Yes	Yes	RCDT320-NL-SC	No	No
RCDT320-EN-SC	Yes	Yes	Italian language		
French Language			RCDT310-IT-SC	Yes	Yes
RCDT310-FR-SC	Yes	Yes	RCDT320-IT-SC	Yes	Yes
RCDT320-FR-SC	Yes	Yes	German language		
German language			RCDT310-DE-SC	Yes	Yes
RCDT310-DE-SC	Yes	Yes	RCDT320-DE-SC	Yes	Yes
RCDT320-DE-SC	Yes	Yes	Spanish language		
Spanish language			RCDT310-ES-SC	Yes	Yes
RCDT310-ES-SC	Yes	Yes	RCDT320-ES-SC	Yes	Yes
RCDT320-ES-SC	Yes	Yes			

SPECIFICATION

RCD Test Ranges (to EN61557-6)

Test Current Accuracy:

No Trip Test: (ΔI) -8% to -2%

Trip Test: (I, 5I) +2% to +8%

Trip Time: $\pm 1\%$ $\pm 1\text{ms}$

Voltage measurement (All Models)

Range ac: 0 V - 300 V 25Hz to 450Hz

Accuracy: $\pm 2\%$ ± 2 digits

Frequency measurement (RCDT320 only)

Range: 25Hz to 450Hz

Accuracy: 25.0Hz to 199.9Hz $\pm 0.1\text{Hz}$

200Hz to 450Hz $\pm 1\text{Hz}$

Fault (Touch) Voltage

Displayed range: 0 V to 50 V (displayed on the analogue bar graph)

Error: +5%/+15% ± 0.5 V

Temperature and humidity

Operating Range: -5°C to +40°C

Operating Humidity: 93% R.H. at +40°C max.

Storage Range: -25°C to +70°C

Maximum altitude: 2000m

Environmental Protection: Weather proof to IP54

Safety

Meets the requirements of EN61010-1 Cat III 300 V phase to earth.

IEC61557

Complies with the following parts of EN61557, Electrical safety in low voltage systems up to 1000 V a.c. and 1500 V d.c. - Equipment for testing, measuring or monitoring of protective measures:

Part1 - General Requirements

Part4 - Residual current devices

Power supply

Batteries: 8 x 1,5 V cells IEC LR6 type (AA alkaline).

Rechargeable: 8 x 1.2 V NiCd or NiMH cells may be used.

Battery condition is constantly shown on the display as a four-section bar graph.

Battery Life: 1000 consecutive tests

Weight

All units 980gms

Dimensions

All units 203 x 148 x 78 mm

E.M.C

In accordance with IEC61326 including amendment No.1

BASIC AND SERVICE ERRORS

Basic and service errors Loop test ranges

Basic and service errors for RCD test ranges ranges.

The basic error is the maximum inaccuracy of the instrument under ideal conditions, whereas the service error is the maximum inaccuracy taking into effect of battery voltage, temperature, interference, and system voltage and frequency, where applicable.

ACCESSORIES AND EQUIPMENT

Item	Order Code
2 wire test lead set and crocodile clips	6220-784
Mains plug test lead (BS 1363)	6220-740
Mains plug test lead CEE 7/7	6220-741
Mains plug test lead (AS/NZS 3112)	6220-790
Test lead case	6220-785
Megger Certification Software	
Powersuite Pro-Lite 16th	6111-697

REPAIR AND WARRANTY

The instrument contains static sensitive devices, and care must be taken in handling the printed circuit board. If an instrument's protection has been impaired it should not be used, but sent for repair by suitably trained and qualified personnel. The protection is likely to be impaired if for example; it shows visible damage; fails to perform the intended measurements; has been subjected to prolonged storage under unfavourable conditions, or has been subjected to severe transport stresses.

NEW INSTRUMENTS ARE GUARANTEED FOR 3 YEARS FROM THE DATE OF PURCHASE BY THE USER.

Note: Any unauthorized prior repair or adjustment will automatically invalidate the Warranty.

INSTRUMENT REPAIR AND SPARE PARTS

For service requirements for Megger Instruments **contact:**

Megger Limited	or	Megger
Archcliffe Road		Valley Forge Corporate Centre
Dover		2621 Van Buren Avenue
Kent CT17 9EN		Norristown PA 19403
England.		U.S.A.

Tel: +44 (0) 1304 502 243 Tel: +1 610 676 8579

Fax: +44 (0) 1304 207 342 Fax: +1 610 676 8625

or an approved repair company.

Approved Repair Companies

A number of independent instrument repair companies have been authorised for repair work on most Megger instruments, using genuine Megger spare parts. A list of approved companies is available from the UK address shown on this page. Spare parts are also available.

Returning an Instrument for Repair

If returning an instrument to the manufacturer for repair, it should be sent freight pre-paid to the appropriate address. A copy of the invoice and of the packing note should be sent simultaneously by airmail to expedite clearance through Customs. A repair estimate showing freight return and other charges will be submitted to the sender, if required, before work on the instrument commences.











Megger Limited
Archcliffe Road, Dover
Kent CT17 9EN England
T +44 (0)1 304 502101
F +44 (0)1 304 207342

Megger
4271 Bronze Way, Dallas,
Texas 75237-1019 USA
T +1 800 723 2861 (USA ONLY)
T +1 214 333 3201
F +1 214 331 7399

Megger
Z.A. Du Buisson de la Couldre
23 rue Eugène Henaff
78190 TRAPPES France
T +33 (0)1 30.16.08.90
F +33 (0)1 34.61.23.77

OTHER TECHNICAL SALES OFFICES

Toronto CANADA, Sydney AUSTRALIA, Mumbai INDIA, Madrid SPAIN and the Kingdom of BAHRAIN.

Megger products are distributed in 146 countries worldwide.

**This instrument is manufactured in the United Kingdom.
The company reserves the right to change the specification or design without prior notice.**

Megger is a registered trademark

Part No. 6172-xxx V01 Printed in England 0503
www.megger.com