

Withstand Testers





MHP1 & MHP2

User Guide

MEGGER[®]

 Safety Warnings	2
General Description	4
Features, Controls and Connections	5
Operation	
Testing Precautions	11
Before each testing sequence	12
Carrying out a test	12
Switched Low Voltage probe <i>LP2</i>	13
120 k Ω resistance Box	14
Specification	15
Accessories	16
Repair and Warranty	17

Symbols used on the instrument

-  Caution: Refer to User Guide
-  Risk of Electric shock
-  Danger of death
-  Protective Ground (Earth) Terminal
-  Equipment complies with current EU Directives.



SAFETY WARNINGS

- ★ High Voltage testing is hazardous. Safety Warnings and Precautions must be read and understood before the instrument is used. They must be observed during use.
- ★ Testing must only be carried out in a dedicated, demarcated, High Voltage testing area which is clearly marked. National and local safety codes and standards must be observed.
- ★ For safety, the instruments must be properly grounded (earthed). A separate protective ground (earth) lead must be correctly connected from the Protective ground (Earth) terminal to a reliable ground (earth) before testing. This is in addition to the ground (earth) wire in the power (mains) lead which must also be connected to provide a double level of safety.
- ★ Suitable external interlocks must be used. The remote control unit is not a safety interlock and must not be used as such.
- ★ The instrument, HV test probe, Low voltage test lead (or LV probe) and any remotely connected equipment must not be used if any part is damaged.
- ★ The HV test probe and Low Return lead (or LV probe) must be confirmed as being in good order, clean, with no broken or cracked insulation before each test sequence.
- ★ Exposed metal parts, including the HV probe tip, LV probe tip, Low return lead clip and the item under test must not be touched during testing, or until completely discharged.
- ★ The High Voltage probe must only be held with the fingers and thumb behind the hand guard.
- ★ Replacement fuses, parts and accessories must be of the correct type and rating.

NOTE

THE INSTRUMENT MUST ONLY BE USED BY SUITABLY TRAINED AND COMPETENT PERSONS

General Description

The *MHP1* and *MHP2* Testers are designed for general Withstand (Flash) testing of electrical equipment and insulating materials. The instruments are operated from a nominal 115 V or 230 V 50/60 Hz mains supply pre-set at the factory, and have a variable output voltage providing up to 3 kV a.c. (*MHP1* and *MHP2*) and up to 4 kV d.c. (*MHP2* only). The instruments are self contained in a sheet steel cabinet, with simple to use controls on the front face of the unit. Customer terminals, accessed behind a rear panel enable connection for external relay control, external indicator beacon and external safety interlocks. An optional remote switch facility is available. The instruments have been designed for indoor use only and as such should not be used in harsh conditions or outside. The instruments are designed for Installation Category II use. Installation Category II relates to transient overvoltages likely to be met on grounded (earthed) receptacles (socket outlets). The instrument is supplied with a 3 wire power cord. The instrument must be used with a grounded (earthed) supply, and all 3 wires must be connected.

The colour code of the cord is :-

	<u>U.S.A.</u>	<u>U.K./International</u>
Ground (Earth)	Green	Yellow/Green
Neutral	White	Blue
Line (Phase)	Black	Brown

Safety features include:-

- ★ Interlock terminals enable automatic disconnection of the test voltage when accessing the device under test.
- ★ High Voltage warning terminals provide a connection for a high visibility beacon.
- ★ Two methods of control allow the user to select the best method for the type of testing undertaken.
- ★ Two independent methods of grounding (earthing), supply cord ground and an additional protective Ground (Earth) terminal located at the rear of the instrument, both of which must be used.

Features, Controls and Connections

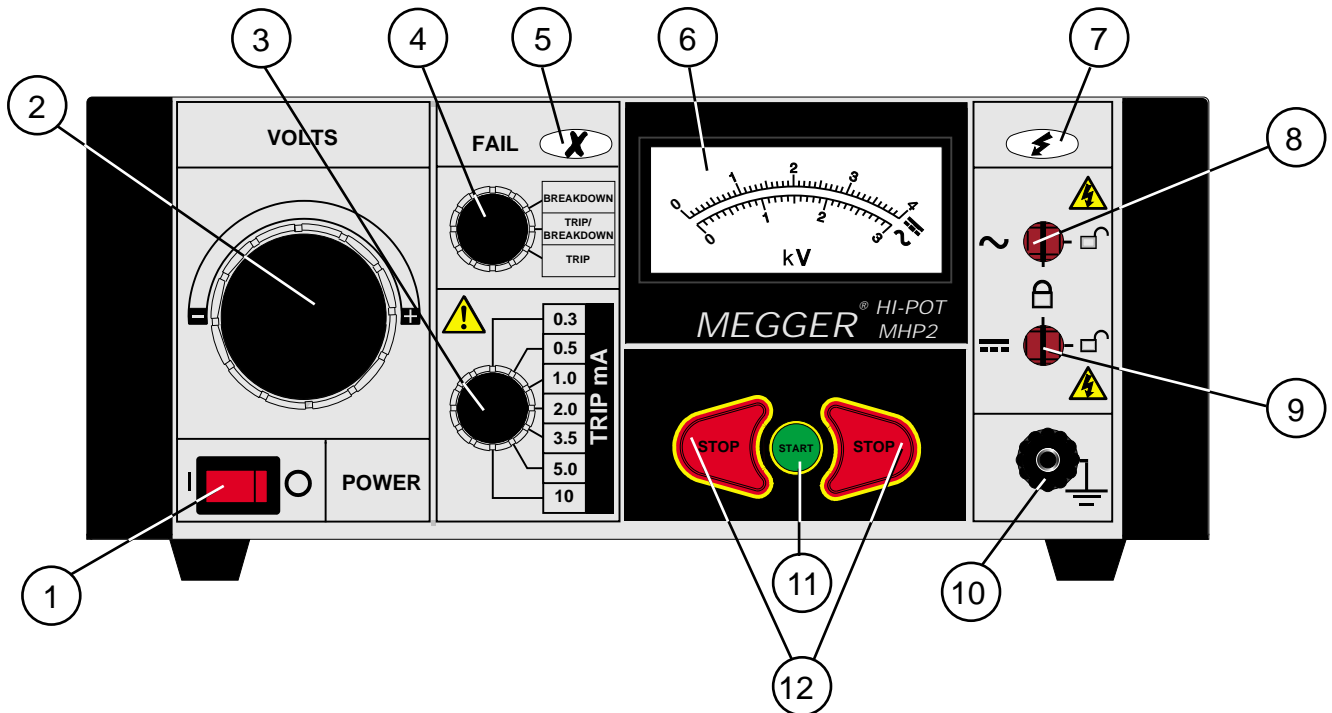

1. Illuminated mains On / Off switch

2. Voltage control knob

3. Trip Level Switch

Sets the current trip limit when testing with the trip or breakdown/trip mode. This level can be set to: 0.3 mA, 0.5 mA, 1.0 mA, 2.0 mA, 3.5 mA, 5.0 mA, 10.0 mA peak a.c. (or d.c. on *MHP2*).

⚠ Warning:- The Trip level Switch does not limit the instantaneous current that can flow from the instrument prior to switchoff. Up to ½ cycle delay will occur before switch off.

4. Test mode select switch

There are two methods of automatically disconnecting the supply:-

i) Breakdown

The test voltage is applied until insulation breakdown (a sharp increase in current independent of continuous leakage current), or user intervention.

ii) Breakdown / Trip

As for Breakdown above, but the test voltage will also be removed automatically if the leakage current exceeds the limit set on the Trip Level Switch.

iii) Trip

The test voltage is automatically removed if the leakage current exceeds the limit set on the Trip Level Switch.

Note:- The test voltage will only be removed automatically if the leakage current exceeds the limit set on the Trip Level Switch.

5. Visual 'Test Fail' indicator

Illuminates to indicate when test conditions have been exceeded. An internal buzzer will also sound when the visual indication is active.

6. Output volt meter

Used in conjunction with the Voltage control to set, and give an accurate indication of output test voltage. After a d.c. test the voltmeter will indicate capacitive discharge voltage at the terminals.

Features, Controls and Connections

7. High Voltage indicator

When the instrument is generating high voltage the indicator is illuminated. The voltage on the terminals will be indicated on the voltmeter at all times.

8. High voltage a.c. output receptacle

The HV receptacles used in the instrument are designed to accept a locking plug. To insert the plug, align the arrows on the plug with the open padlock symbol, push in, and then turn the plug through 90° to align the arrows with the closed padlock symbol. This will now lock the plug into the instrument. To remove, turn the plug to align the arrows with the open padlock symbol and withdraw.

9. High voltage d.c. output receptacle. (MHP2 only)

The H.V. d.c. receptacle locking facility is identical to the a.c. receptacle. The internal H.V. capacitors are protected by a built-in integral impedance. This effectively causes the d.c. output voltage to fall, as the test current is drawn. See 'Specification'.

High Voltage probe

The High Voltage probe is designed to lock into the High voltage receptacle(s) and is fitted with a hand guard, and a spring loaded electrode cover which retracts as the probe is pressed to the item being tested. See 'Accessories' for replacement probe.

⚠ Warning:- The probe must not be used in a damaged or dirty state. Do not touch any part of the HV probe in front of the guard or the device under test, until completely discharged.

⚠ Warning:- Care must be taken not to touch the probe to any adjacent ungrounded (unearthed) metalwork such as pipes, window frames etc. as this may become hazardous live.

10. Low Return terminal

The Low Return lead must be connected to this terminal. The terminal is internally connected to the instrument ground (earth). The Low Return lead is fitted with a hook connector so that it will not pull off the terminal. To check this lead, see 'Before each testing sequence'. A replacement low voltage lead is available, see 'Accessories'.

11. Start button

Controls the high voltage output. Either of two modes of operation can be selected and set using a moveable link situated behind the rear panel cover:-

- i) The latched mode (link to the right) allows the user hands free operation. Operation of the Stop button, quickly followed by the Start button causes HV generation until the test fails, or the Stop button is pressed.
- ii) The unlatched mode (link to the left) requires the Stop button to be pressed, followed quickly by the Start button, which must be held in for the entire test. The test can be stopped at any time by releasing the Start button or by pushing the Stop button. The instrument will halt the test should the test parameters be exceeded.

12. Stop button

When pushed the stop button:-

- ★ Stops the test
- ★ Resets a failure indication.
- ★ Initiates a start sequence. To avoid inadvertent test voltage application, the test

Start sequence requires the Stop button to be pressed first, followed by pressing the Start button within 1 second.

On the rear panel, other features of the instrument can be accessed:-

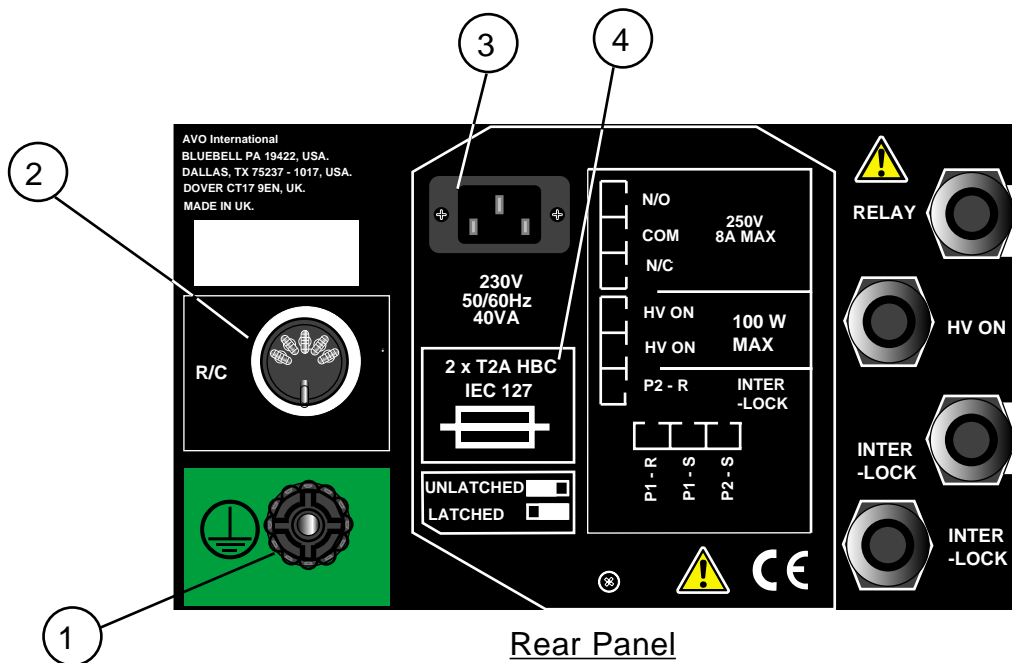

Rear Panel

1. Protective Ground (Earth) terminal

For safety, the instruments must be properly earthed. A protective ground (earth) lead must be correctly connected from the this terminal to a reliable ground (earth) before testing.

⚠ Warning:- The IEC power supply cord connection to ground (earth) must not be solely relied upon. If the ground (earth) connection of the IEC lead becomes disconnected, or defective, the metal instrument case could become 'live' rising to the dangerously high output voltage of the instrument. A second ground must be connected to the protective ground terminal on the rear of the instrument.

2. R/C Remote On /Off receptacle

The optional AVO remote On / Off unit *RC1* plugs into this receptacle allowing remote activation of the unit (see 'Accessories').

⚠ Warning:- The remote On / Off unit is not a safety interlock and must not be used as such.

3. IEC Line connector

Provides a means of disconnection from the line supply. To gain access to the line supply fuses, the Start button mode link, and the customer terminals, the IEC line connector must be removed from the instrument. The screw holding the cover in position is then removed and the cover can be swung up out of the way, exposing the interface terminals, Start button mode link, and fuses.

4. Fuse Replacement

The fuses provide protection for the user and instrument. To gain access to the fuses, remove the IEC mains connector from the instrument. The screw holding the cover in position is then removed and the cover can be swung up out of the way, exposing the fuses. Replacement fuses must be of the correct type and rating. See 'Specification'.

Features, Controls and Connections

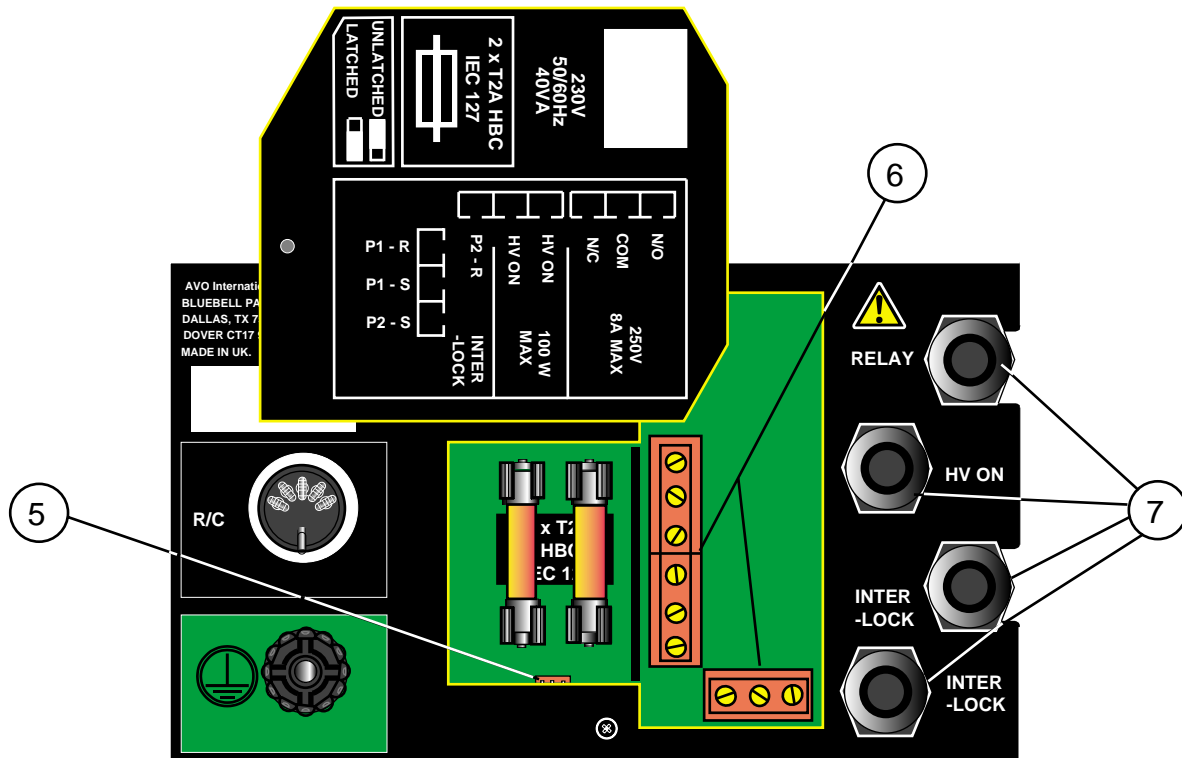

Terminal connections and fuses

5. Start mode link (under cover plate)

To gain access to the Start mode link, remove the IEC mains connector from the instrument. The screw holding the cover in position is then removed and the cover can be swung up out of the way, exposing the Start button mode link. The link has two positions; to the left provides the unlatched mode, to the right provides the latched mode. Gently pull to remove the link from the terminals, and re-position as required.

6. Interface and Interlock terminals (under cover plate)

To gain access to the interface terminals, remove the IEC mains connector from the instrument. The screw holding the cover in position is then removed and the cover can be swung up out of the way, exposing the interface terminals. The terminals are not suitable for solid core wires. Multi-stranded conductors, 22-16 AWG (1mm² - 1,5 mm²) should be used. The use of wire ferrules is recommended to eliminate stray strands of wire; recommended insulation strip length is 8 mm. The terminal screws should be tightened securely. On completion, the cover plate should be swung back into position and secured by replacing and tightening the cover plate retaining screw.

Terminal connections and fuses

The interface terminals are in three groups:-

i) Relay Terminals

The top three terminals are for applications that require an external test status indication. 'Test Failed' and 'Test OK' can be signalled. The maximum current that can be switched is 8 Amp at 250 Volts.

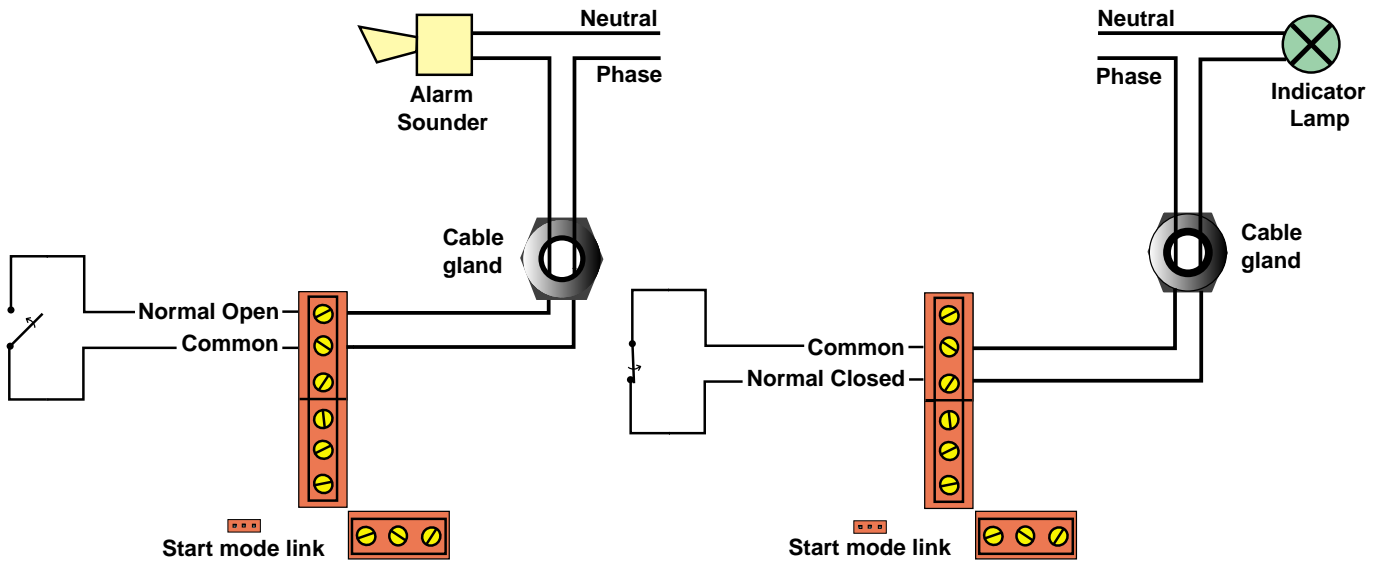

When the 'Failed' condition is active, the Common terminal is shorted to the Normally Open (N/O) terminal.

When the 'Failed' condition is active the Common terminal and the Normally Closed (N/C) terminal are open circuited by the instrument.

To gain access to the relay terminals, the IEC line connector must be removed from the instrument. The screw holding the cover in position is then removed and the cover can be swung up out of the way, exposing the interface terminals.

ii) HV On Terminals

Some regulations call for various signalling lamps to indicate hazardous and potential Risk situations. The terminals shown allow for the connection of a Line powered 'High Voltage On' indicator or beacon. See 'Accessories' for Warning beacon. A maximum current of 1/2 Amp can be drawn from these terminals.

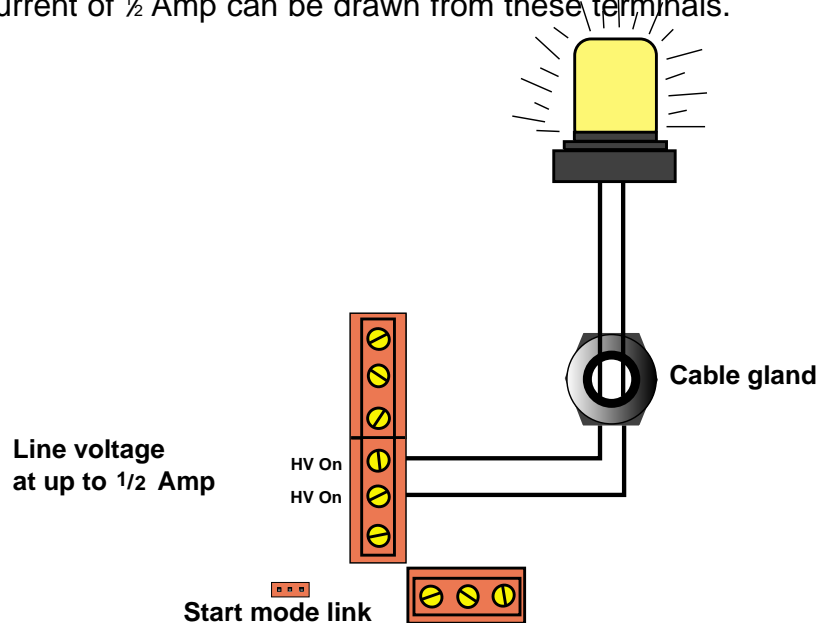

HV 'On' terminal connections

Features, Controls and Connections

iii) HV Interlock Terminals

The bottom four terminals enable the HV supply to be safety interlocked. The instrument is supplied without the interlock terminals connected. The HV interlock terminals must be connected before the instrument will generate High Voltage. The Users HV safety interlock system must conform to National and Local safety codes and be designed in such a way that any contact with live parts is prevented. This is normally achieved by a solid barrier that must be removed before access can be obtained to the hazardous area. The action of removing the barrier forces the interlock switches to the open position thus interrupting the supply voltage for the HV generation circuit. The interlock connections operate at Line (mains) voltage. All wiring connected to these terminals must be rated for Line (mains) use and capable of carrying a current of 3 amps.

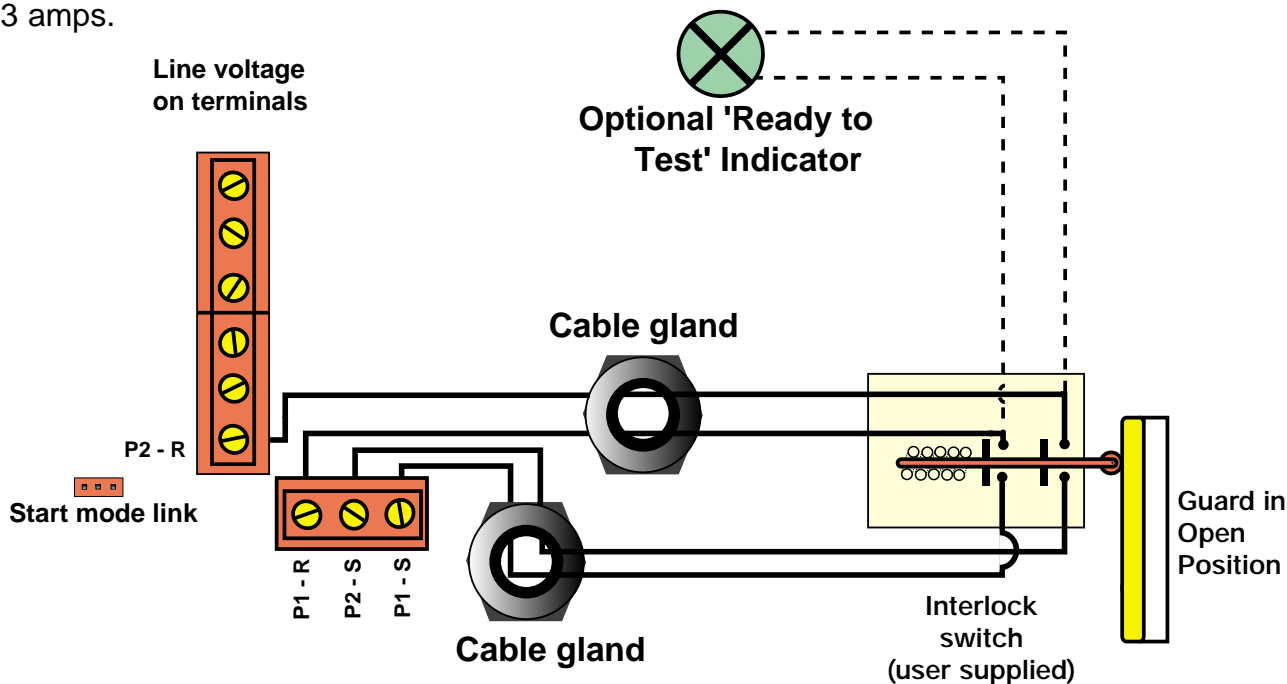

Interlock connection example

7. Cable entry glands

When wiring the safety interlocks, the wires to the terminals must pass through the cable entry glands and then be connected to the appropriate terminals. Cables of 1/8" to 1/4" (3 mm to 6.5 mm) outer insulation diameter can be used. The glands must be sufficiently tightened, after wiring, so that flexing the external cord does not cause any movement of the wires inside the panel. On completion, the cover plate should be swung back into position and secured by replacing and tightening the cover plate retaining screw.

Operation

Testing Precautions

- ★ High voltage testing is potentially lethal. Care must be taken at all times to ensure that risks to safety are eliminated.
- ★ The instruments must only be used by suitably trained and competent persons.
- ★ The instrument User is responsible for their own safety and that of others who may come into contact with dangerous voltages as a result of a test.
- ★ For safety, the instrument must be double grounded (earthed) to known good ground (earth) point. Firstly by the line powercord, and secondly from the rear protective ground (earth) terminal. During the installation process both ground (earth) connections should be checked to prove their integrity. See 'Before each testing sequence'.
- ★ Before operating the Line On / Off switch, ensure that the voltage control is set to minimum. If this is not done a voltage transient could occur at the output terminal which could cause damage to the item under test or endanger the user.
- ★ When making connections to the instrument, and to the device to be tested, ensure the instrument is in a safe condition, with all safety interlocks open.
- ★ If any part of the instrument is damaged, it should not be used, but returned to the manufacturer or an approved organization for repair.

Charged Circuit Discharge

For d.c. tests and when testing capacitors or equipment containing capacitors, extra care must be taken by the User to ensure that the item under test is fully discharged before handling. The instrument provides a discharge path which will discharge 0,5 μ F in 10 seconds. Even a small deflection of the voltmeter may represent a hazardous voltage.

 **Warning:-** Care must be taken to prevent capacitive circuits becoming disconnected during a test, leaving the circuit in a charged state. Automatic discharge must not be relied upon as an alternative to normal safe working practice.

Dielectric Absorption

Some capacitive items exhibit an effect called Dielectric Absorption. The dielectric can absorb charge during the test. After the item is discharged, the absorbed charge is released back onto the capacitive 'plates' effectively raising the voltage of the item, possibly to dangerous levels. Safe working practice dictates that tested items should be firmly shorted out with a shorting link, after discharge, until required for use.

- ★ The instrument is supplied with a 3 wire power cord. The instrument must be used with a grounded (earthed) supply, and all 3 wires must be connected.

The colour code of the cord is :-

	<u>U.S.A.</u>	<u>U.K. / International</u>
Ground (Earth)	Green	Yellow/Green
Neutral	White	Blue
Line (Phase)	Black	Brown

If using a fused plug, a 3 Amp fuse to BS1362 should be fitted.

Operation

Before each testing sequence:-



High Voltage testing is hazardous. Safety Warnings and Testing Precautions must be read and understood. They must be observed during use.

1. Decide upon the Start mode required, and connect the Start mode link in the appropriate position.
2. Check the condition of the HV probe and test lead (or LV probe) to ensure that they are in good order, clean, with no broken or damaged insulation. A daily Continuity test is recommended. To check the HV probe and test lead (or LV probe):-
 - i) Plug the HV probe in the a.c. HV receptacle.
 - ii) Ensure that the Low Return lead (or LV probe) is firmly secured to the Low return terminal.
 - iii) Set the voltage control to minimum.
 - iv) Set the trip mode to TRIP and set the trip current limit to 0.3 mA.
 - v) Switch the instrument on. The switch illuminates.
 - vi) Short the HV probe and the end of the Low Return lead (or LV probe) together.
 - vii) Start the instrument and slowly increase the voltage.
3. The instrument should trip before the voltmeter pointer moves. If the pointer moves, the test leads are suspect, and must be fully, and properly inspected.



The condition of the HV probe and test lead is critical to overall safety. A faulty or damaged HV probe or test lead must not be used under any circumstances.

4. Ensure that the voltage control is set to minimum before operating the line power switch. If this is not done a voltage transient could occur at the output terminal which could cause damage to the item under test or endanger the user.
5. Check that all interlocks are fully operational.

Carrying out a test



High Voltage testing is hazardous. Safety Warnings and Testing Precautions must be read and understood. They must be observed during use.

1. Set the required:-
 - i) Test mode (Breakdown - Trip / Breakdown - Trip)
 - ii) Trip level (0.3 mA to 10 mA)
2. Connect the HV probe and the Low Return lead to appropriate points of the device under test. For safety it is advisable to connect the HV to the least accessible part of the item under test.
3. Close all interlocks.
4. Switch the instrument on. The switch illuminates.
5. Push the Stop button, followed quickly by the Start button. (Depending on the selected

mode the Start button is released, or held for the duration of the test).

6. Once the HV circuit is energised, adjust the voltage to the test level required.

Note:- It is advisable to slowly increase the test voltage from a low value, giving the insulation within the device under test, time to react to the stress. This will also reduce false tripping due to switching On at the required test level. This is especially true for d.c. tests.

7. If the test fails, the failed indication will light and the buzzer will sound. Repeat the test to confirm the failure.
 8. Press the Stop button to switch the High Voltage off and to reset the failure indication.
 9. To stop the test after the correct time press, the Stop button (or release the Start button).
-  On completion, open all safety interlocks. Switch the Withstand tester Off.

Note:- When performing an a.c. test, capacitance of the test leads can cause a small leakage current. Typically, this is in the order of 20 μ A per metre, for each 1000 V of test voltage. This effect is normal, but may cause the instrument to trip at a lower level of leakage than expected. This effect is most noticeable at the lower trip ranges. It is therefore important to consider this effect before extending the test leads in any way.

Switched Low Voltage probe LP2

In conjunction with the HV probe provided, the optional LV probe allows remote activation of the Withstand tester enabling fast, safe probing of the item under test.



High Voltage testing is hazardous. Safety Warnings and Testing Precautions must be read and understood. They must be observed during use.

1. Refer to 'Carrying out a test'.
 2. Connect the probe DIN plug to the R/C socket, and firmly secure the hook terminal to the Low return terminal. Connect the HV probe to the appropriate HV receptacle.
 3. Switch the Withstand tester on and set the Test mode, Trip level, and Voltage as required. Check that all safety interlocks are closed.
 4. Firmly hold both probes to the item under test. For safety it is advisable to hold the HV probe to the least accessible part of the item under test.
 5. Squeeze the LV probe switch to start the test.
 6. Release the LV probe switch to stop the test.
 7. As required, move the probe around the item under test, operating the probe switch as appropriate.
 8. If the test fails, the 'Fail' indicator will light, and the buzzer will sound.
 9. To reset the Withstand tester 'Fail' indicator, disengage the probes, and briefly squeeze the LV probe switch. Repeat the test to confirm a test 'Fail'.
-  On completion, open all safety interlocks. Switch the Withstand tester Off.

Operation

120 kΩ Resistance Box

This optional accessory is used to check that the instrument will operate and indicate correctly, when an item under test has significant insulation leakage current.



High Voltage testing is hazardous. Safety Warnings and Testing Precautions must be read and understood. They must be observed during use.

1. Refer to 'Carrying out a test'.
2. Firmly connect the supplied lead from the Resistance Box to the instrument Low return terminal. Connect the HV probe to the appropriate HV receptacle.
3. Switch the Withstand tester on and set the Test mode, Trip level, and Voltage as required. Check that all safety interlocks are closed.
4. Firmly hold the instrument HV probe to the Resistance Box test point stud.
 - ⚠ The HV probe tip, and the resistance box must not be touched during the operation.
5. Start the instrument.
6. The instrument should instantly indicate 'Fail', and sound the buzzer.
7. Press the Stop push to reset the Withstand tester. Repeat the test to confirm a test 'Fail'.
 - ⚠ On completion, open all safety interlocks. Switch the Withstand tester Off.

Note:- If the instrument does not operate within 5 seconds, Stop the Test (to prevent excess heat damage to the Resistance Box).

Specification

	<u>MHP1</u>	<u>MHP2</u>
Test Voltage:	0 - 3 kV a.c.	0 - 3 kV a.c. 0 - 4 kV d.c.
d.c. ripple content:	<150 V d.c. pk - pk at 1 mA	
Display:	Analogue movement - Sifam 29W	
Display Accuracy:	± 2.5% of full scale deflection	
Current Trip:	Peak or d.c. 0.3 mA, 0.5 mA, 1.0 mA, 2.0 mA, 3.5 mA, 5.0 mA, 10.0 mA	
Current trip accuracy:	± 10% of indicated value - 0.3 mA and 0.5 mA ranges ± 5% of indicated value - All other ranges	
Typical Cap. leakage:	25 μ A per 1000 V test voltage - Standard probe (5310-406)	



115 V. instrument

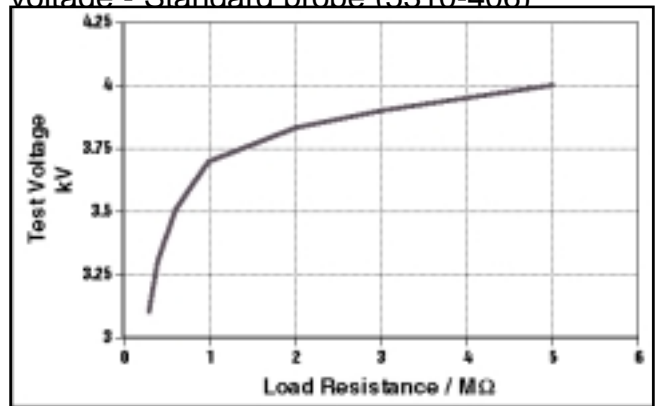

230V. instrument

Typical d.c. Loading

Safety:	Meets the requirements of IEC 1010-1 (1995) EN61010-(1995)
Fuses:	2 x T2A HBC 1¼" x ¼" (32 mm x 6,5 mm) Line power cord fused plug (when applicable): 3 Amp fuse to BS 1362
EMC:	Meets EN50081-1, EN50082-1 (1992). Meets EN61326-1 in the following categories:- IEC10004-2 Cat A; IEC10004-3 Cat A; IEC10004-4 Cat A; IEC10004-5 Cat C; IEC10004-11 Cat A.
Temperature:	
Operating:	32° F to 104° F (0° C to 40° C)
Storage:	4° F to 140° F (-20° C to 60° C)
Humidity:	
Operation:	80% RH at 104° F (40° C)
Note:-	After storage in high humidity, or moving from a cold to warm environment, allow the instrument to sit for at least 3 hours before use.
Dimensions:	11" x 11½" x 4¾" (257 mm x 280 mm x 110 mm)
Weight:	17. 6 lb (8 kg)

Repair and Warranty

The instrument circuit contains static sensitive devices, and care must be taken in handling the printed circuit board. If the protection of an instrument has been impaired it should not be used, and be sent for repair by suitably trained and qualified personnel. The protection is likely to be impaired if, for example, the instrument shows visible damage, fails to perform the intended measurements, has been subjected to prolonged storage under unfavourable conditions, or has been exposed to severe transport stresses.

New Instruments are Guaranteed for 1 Year from the Date of Purchase by the User.

Note:- Any unauthorized prior repair or adjustment will automatically invalidate the Warranty.

Instrument Repair and Spare Parts

For service requirements for *MEGGER*® Instruments contact :-

AVO INTERNATIONAL or	AVO INTERNATIONAL	or	MEGGER SARL
Archcliffe Road	Valley Forge Corporate Center		29 Allée de Villemomble
Dover	2621 Van Buren Avenue		93340, Le Raincy
Kent, CT17 9EN.	Norristown, PA 19403		Paris
England	U.S.A.		France
Tel: +44 (0) 1304 502243	Tel: +1 (610) 676-8579		Tel: +33 (1) 43.02.37.54
Fax: +44 (0) 1304 207342	Fax: +1 (610) 676-8625		Fax: +33 (1) 43.02.16.24

or an approved repair company.

Approved Repair Companies

A number of independent instrument repair companies have been approved for repair work on most *MEGGER*® instruments, using genuine *MEGGER*® spare parts. Consult the Appointed Distributor / Agent regarding spare parts, repair facilities and advice on the best course of action to take.

Returning Instrument for Repair

If returning an instrument to the manufacturer for repair, it should be sent freight pre -paid to the appropriate address. A copy of the Invoice and of the packing note should be sent simultaneously by airmail to expedite clearance through Customs. A repair estimate showing freight return and other charges will be submitted to the sender, if required, before work on the instrument commences.

Accessories

Cleaning: Wipe disconnected instrument with a clean cloth dampened with soapy water or Isopropyl Alcohol (IPA).

Supplied	Part Number
User Guide	6172-314
Mains Power cord	
Low Return lead	6220-309
4 kV High Voltage Probe	
Optional	
Retractable type High Voltage Probe <i>HP1</i>	6420-061
Warning Beacon	6121-446
Remote On / Off switch unit <i>RC1</i>	6220-641
120 k Ω Resistance Box	6121-447
Switched Low Voltage probe <i>LP2</i>	6121-456

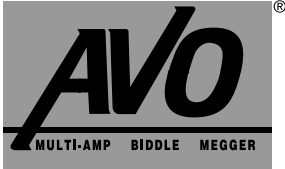

AVO INTERNATIONAL

Archcliffe Road
Dover, Kent
CT17 9EN
England.

Tel: +44 (0) 1304 502100
Fax: +44 (0) 1304 207342

4651 S. Westmoreland Road
Dallas
TX 75237-1017
U.S.A.

Tel: +1 (800) 723-2861 (U.S.A. only)
Tel: +1 (214) 330-3203 (International)
Fax: +1 (214) 337-3038

PO Box 9007
Valley Forge
PA 19484-9007
U.S.A.

Tel: +1 (610) 676-8569
Fax: +1 (610) 676-8610

MEGGER SARL
29 Allée de Villemomble
93340, Le Raincy
Paris
France

Tel: +33 (1) 43.02.37.54
Fax: +33 (1) 43.02.16.24

This instrument is manufactured in the United Kingdom. The Company reserves the right to change the specification or design without prior notice.

MEGGER and AVO are registered Trade Marks of AVO INTERNATIONAL LIMITED. Copyright© AVO INTERNATIONAL LIMITED.

Part Number 6172-314 - Edition 5 - Printed in England - 07FF

LEET