

Megger[®]

LRC200 Series Combined Loop and RCD Tester

USER MANUAL



SAFETY WARNINGS

- **Safety Warnings** and **Precautions** must be read and understood before the instrument is used. They **must** be observed during use.
- Continuity of protective conductors and earthed equipotential bonding of new or modified installations **must** be verified **before** carrying out RCD tests, or earth fault loop impedance tests.
- Do not leave the instrument connected to the mains supply when not in use.
- Circuit connections and exposed metalwork of an installation or equipment under test must not be touched.
- Ensure that hands remain behind guards of probes/clips when testing.
- The instrument should **not** be used if any part of it is damaged.
- Test leads, probes and crocodile clips **must** be in good order, clean and with no broken or cracked insulation.
- The battery cover must be in place whilst conducting tests.
- Voltage indicator LED's cannot reveal a N-PE supply reversal.
- National Safety Authorities may recommend the use of fused test leads when measuring voltage on high-energy systems.
- When making a 2 wire measurement with the 3 wire lead set, for safety reasons the black test lead should be connected together with the green test.

NOTE

THE INSTRUMENT MUST ONLY BE USED BY SUITABLY TRAINED AND COMPETENT PERSONS.

Users of this equipment and/or their employers are reminded that Health and Safety Legislation requires them to carry out valid risk assessments of all electrical work so as to identify potential sources of electrical danger and risk of electrical injury such as inadvertent short circuits.

Some national safety authorities recommend fused leads for voltage measurement on high energy systems. If RCD or Loop tests are made it may cause the fuse to rupture, and so they must be used with caution on voltage testing.

CONTENTS

Safety warnings	3	Replacing batteries and fuses	19
Introduction	4	Low battery warning symbol	19
General description	5	To replace batteries	19
Case contents	5	Fuse blown indication	19
LCD Display	6	Preventive maintenance	20
Front panel	6	Technical specification	20
Connection panel	7	Basic and service errors	22
Lid open/closure	7	Accessories and equipment	23
Preparations for use	8	Repair and Warranty	24
Batteries	8		
Preliminary test lead check	8		
General operating instructions	8		
Display warning symbols	9		
Setup procedure	9		
Reverse polarity or line/neutral swapping	9		
Test leads	10		
Test lead connection.	10		
LED indicators	11		
Loop testing	12		
Non-tripping loop test [No Trip]	12		
Hi current loop test [Hi]	12		
Phase-Earth loop impedance (not at a power socket):	12		
Phase-Neutral or Phase-Phase loop impedance	13		
Prospective fault current display [PFC]	13		
Warning messages	13		
Possible sources of error	14		
Residual current device (RCD) testing	14		
Voltage measurement	17		
Phase to earth voltage measurement	17		
Frequency Hz	17		
Phase sequence (LRCD220 only)	18		

Symbols used on the instrument are:



Caution: refer to accompanying notes



Equipment protected throughout by Double Insulation (Class II)



Equipment complies with current EU directives.



Equipment complies with 'C tick' requirements

INTRODUCTION

Thank you for purchasing the Megger LRCD200 series.

For your own safety and to get the maximum benefit from your instrument, please ensure that you read and understand the following safety warnings and instructions before attempting to use the instruments.

This user manual describes the operation and functions of the following LRCD series of Loop and RCD testers:

LRCD200

LRCD210

LRCD220

GENERAL DESCRIPTION

The LRCD200 series test instruments have the following features

	LRCD200 (not UK)	LRCD210	LRCD220
Loop testing			
Non tripping loop test	■	■	■
PFC	■	■	■
Single phase	■	■	
Hi current loop test			■
Phase to phase			■
3 phase safe	■	■	■
Voltmeter	■	■	■
RCD test			
1/2 x I test		■	■
1 x I test	■	■	■
5 x I test		■	■
Auto RCD			■
Touch/ Contact voltage display	■	■	■
Selectable 25/50 V touch voltage	■	■	■
10, 30,100, 300, 500 mA ranges	■	■	■
1000 mA			■

CASE CONTENTS

	LRCD200 (not UK)	LRCD210	LRCD220
DC Selective RCD tests	■	■	■
Selectable phase 0/180	■	■	■
Ramp test (20% to 110%)	■	■	■
General testing			
Frequency	■	■	■
Phase rotation			■
Reverse polarity operation (Continental instruments only)	■	■	■
Backlight			■
Mechanical			
BS1363, CEE7/7, AS/NZS 3112 plug variants	■	■	■
IP54	■	■	■
Working voltage 230 V	■	■	
Working voltage 110 & 230 V			■
Calibration certificate	■	■	■

There are important documents that you should keep for future reference.

Please complete the warranty card and return it to Megger as soon as possible to help us reduce any delays in supporting you should the need arise.

Carton contents LRCD200, LRCD210 and LRCD220

- 1 x LRCD series loop tester
- 1 x 3 wire test lead with prods with clips
- 1 x Plug ended test lead
- 8 x AA (LR6) batteries (fitted in instrument)
- 1 x Warranty card
- 1 x Certificate of test
- 1 x Calibration certificate
- 1 x CD containing user manual
- 1 x Quick start guide

LCD DISPLAY

FRONT PANEL

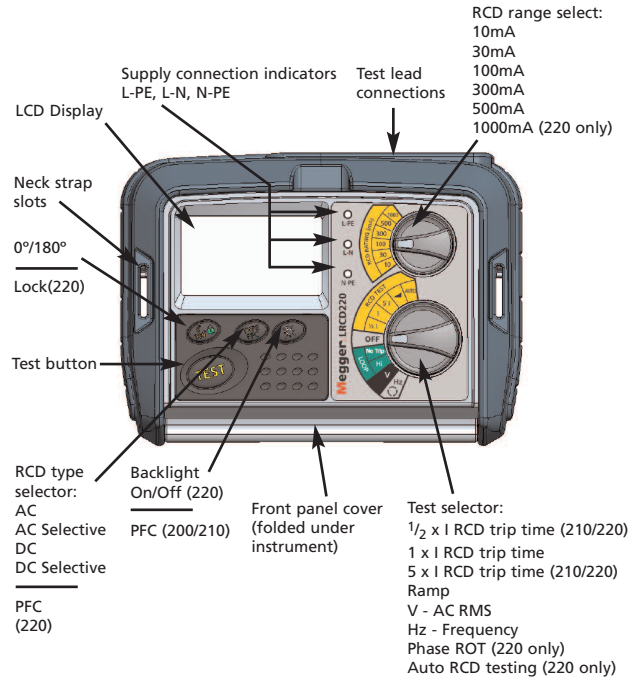
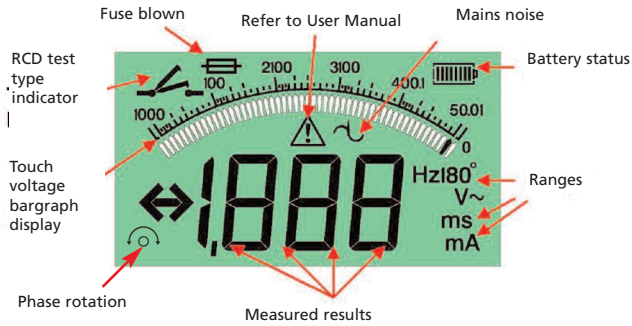

REAR PANEL CONNECTIONS

LRCD 200/210

Earth connection or 2nd Phase connections (220 only)

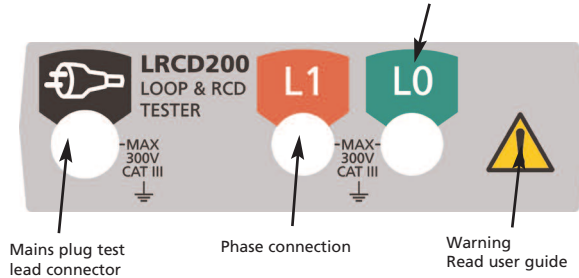

LRCD220

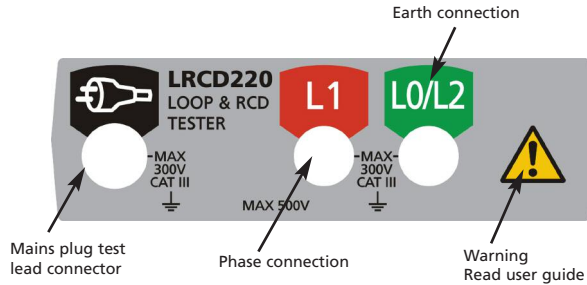

CONTROL PADS

LRCD200



LRCD220



Lid open/closure

1. Open lid by lifting up front panel tab (1).
2. Fold-away underneath instrument (2 & 3) and push into retaining slot (4).

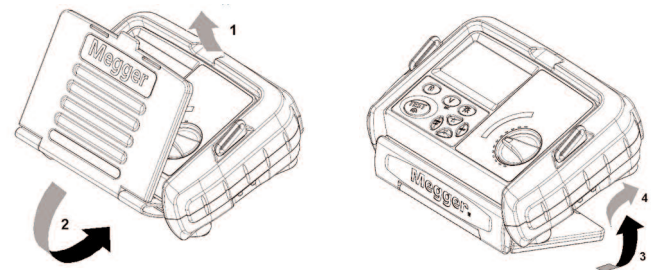

PREPARATIONS FOR USE (ALL INSTRUMENTS)

Batteries

The Megger LRCD series instruments are supplied with batteries fitted. When batteries become exhausted, refer to page 19, battery replacement.

Warning: Do not switch the instrument on with the battery cover removed.

Preliminary test lead check

Functional verification

Before each use of the instrument visually inspect the test leads, prods and crocodile clips to confirm that their condition is good, with no damaged or broken insulation.

GENERAL OPERATING INSTRUCTIONS

Tests lock (LRCD 220 only)

The LOCK  indicates when the [Hi] current loop test range is locked ON.

It is activated by holding down the  lock button, and pressing the [TEST] button. When activated, the [Hi] current loop resistance measurement will start when the instrument is connected to a voltage.

The test lock remains on for 30 seconds, after which it resets to off.

Test inhibit

The following conditions may cause the instrument to inhibit testing:

Out of range supply voltage

If an out of range voltage or frequency exists on the circuit under test, or on a very noisy mains supply, testing will be automatically inhibited. The RCD tests requires a minimum supply voltage to operate.

If the warning <***V is displayed, the supply voltage is below that required to perform an RCD test.

*** = supply voltage indication.

Overheating

Repetitive loop testing generates heat within the instrument. If this heat becomes excessive the instrument will warn the operator and prevent further testing until the instrument has had a chance to cool down.

Fuse Blown

A fuse blown will prevent the instrument from making further tests. The fuse indicator will be displayed.

Default voltmeter

The default voltmeter automatically operates in all test modes, indicating connection to a live system.

Auto Power-down

To extend battery life the instrument will automatically switch off six minutes after the last operation.

The instrument can be switched off manually by selecting [OFF] with the rotary switch, or switched back on again by pressing the [TEST] button.

Backlight operation (LRCD 220 only)

The LRCD LCD display may be backlit, to allow readings to be seen in adverse lighting conditions. The backlight function can be selected at any time while the instrument is switched on by pressing the BACKLIGHT  button.

The backlight function will switch off automatically 15 seconds after the instrument has finished testing.

Display warning symbols



Refer to user manual.

Any time the warning triangle is displayed the operator should refer to the user manual for further information.



Range lock

Displayed at any time the [TEST] button is locked in the on position.



Battery condition indication. Refer to page 19.



Fuse blown indicator, appears when an instrument fuse has failed. Refer to page 19.

>280V Displayed on the LRCD200/210 indicates a supply voltage in excess of that allowed is present.

>480V Displayed on the LRCD220 indicates a supply voltage in excess of that allowed is present.

hot Indicates the instrument needs to cool down before it can continue loop testing



Noise on the circuit under test may affect the reading

Setup Procedure

Reverse polarity or line/neutral swapping

This feature is only available on the following models:

LRCD200-EN-SC	LRCD210-EN-SC	LRCD220-EN-SC
LRCD200-FR-SC	LRCD210-FR-SC	LRCD220-FR-SC
LRCD200-DE-SC	LRCD210-DE-SC	LRCD220-DE-SC
LRCD200-NL-SC	LRCD210-NL-SC	LRCD220-NL-SC
LRCD200-ES-SC	LRCD210-ES-SC	LRCD220-ES-SC

The set-up menu allows the user to change the way the instrument behaves when testing on a supply with Line and Neutral connections swapped. Tests may be permitted or prohibited.

To select Polarity reversal acceptance or rejection:

1. With the instrument switched OFF, hold down the [TEST] button and turn the range knob to any ON position.
2. Keep the button held down until the instrument displays the 'SET' warning.
3. Now release the [TEST] button.
4. Press the [TEST] button again to view the current setting for line/neutral swapping.
5. The display shows 'L+L' (instrument will perform tests with L & N

swapped) or 'L+N' (instrument will not perform tests with L & N swapped).

6. Press the [LOCK] button or the PFC button to change the setting.
7. Press the [TEST] button to exit from the set-up menu.

RCD Touch voltage selection

To set the touch voltage inhibit limit:

1. With the instrument switched OFF, hold down the [TEST] button and turn the range knob to any ON position.
2. Keep the button held down until the instrument displays the 'SET' warning.
3. Now release the [TEST] button.
4. Press the [TEST] button twice to view the current settings for the touch voltage.

The display shows the fault voltage limit, '25 V' or '50 V'.

If the fault-voltage display is active, a bar-graph display will also appear.

5. Press the [0°/180°] button to change the limit setting from 25V to 50V and back.
6. Press the [TYPE] button to turn bar-graph display ON or OFF.
7. Press the [TEST] button to exit from the set-up menu.

Test leads

All test leads form part of the measuring circuit of the instrument and must not be modified or changed in any way, or be used with any other electrical instrument or appliance.

The mains plug test lead supplied with the Megger Tester is a test lead that forms part of the measuring circuit of the instrument. The overall length of this lead must not be altered. If the power cord plug is not suitable for

your type of socket outlets, do not use an adaptor. You may change the plug once only by cutting the cord as close to the plug as possible and fitting a suitable plug.

The colour code of the cord is:

Earth (Ground)	Yellow/Green
Neutral	Blue
Phase (Line)	Brown

Note: A plug severed from the power cord must be destroyed, as a plug with bare conductors is hazardous in a live socket outlet.

Test lead connection

The supplied test leads should be connected to the appropriate sockets on the rear of the instrument marked L0 and L1, or to the 3 way test socket. Standard test probes and crocodile clips are supplied for connection to the circuit under test.

The test lead supplied with the LRCD200, LRCD210 and LRCD220 provides connection for 3 wire testing, using the 3 wire (red, black and green) lead set (6220-782) or mains plug lead (6220-740).

Application

This instrument may be connected live to earth or between live conductors of systems that have a rated voltage of 300V a.c. rms to earth and an installation (overvoltage) Category III or lower.

This means that the instrument may be connected to any fixed wiring of a building installation, but not to primary supply circuits such as overhead cables. To maintain user safety and ensure accurate measurements, only use the test leads supplied or by Megger Limited.

LOOP TESTING

System Diagram - Where To Use Each Test

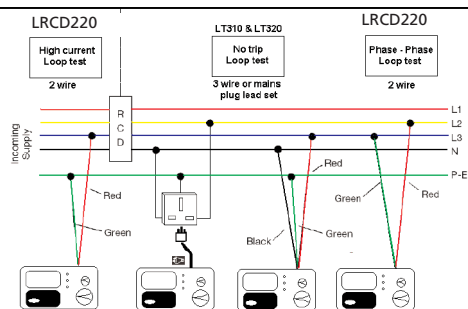

RCD TESTING

System Diagram - Where To Use Each Test

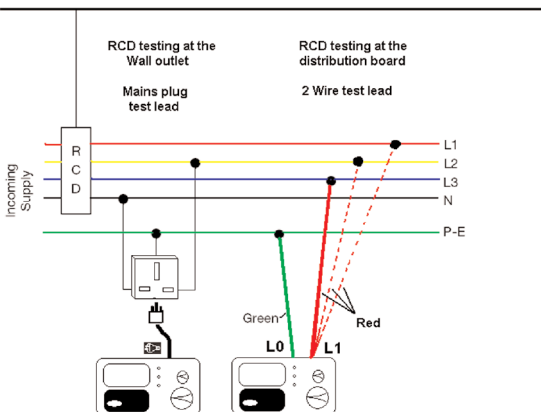

LED indicators

Three RED led indicators show circuit connection status when correctly connected to a live circuit. These are for indication purposes only and should not be relied upon as a indication of the presence of a hazardous voltage.

When connected to the circuit to be tested the three status LED's will show the following supply connection information:

LED Indicator	Normal Supply	Reversed (L-N) supply	Notes
L - PE			Voltage between L- PE greater than 25 V ● = ON ○ = OFF
L - N			Voltage between L-N greater than 25 V
N - PE			Voltage between N-PE greater than 25 V

Warning: Voltage indicator LED's cannot reveal a N-PE supply reversal

Polarity Indication

If connected to a single phase power supply by a plug or by the 3-wire lead set, three LED's marked L-PE, N-PE and L-N will indicate supply polarity

Note: The presence of a voltage between phase and earth does not prove earth continuity, as the earth could have a high resistance and a voltage would still be measured. To test earth continuity refers to the sections on loop testing.

LOOP TESTING

Two loop testing options are available: [No Trip] on the LRCD200/210 and [Hi] test on the LRCD220.

Non-tripping loop test [No Trip]

Earth loop impedance measurement (at a power socket):

The [No Trip] range is a high resolution (0,01 ohm), low test current earth loop resistance measurement range. It requires a connection to neutral, but allows quick and accurate measurement of the earth loop resistance without tripping all RCDs with a rated current 30 mA or higher.

To perform a [No-Trip] loop test:

Range selection:

1. Select the [No Trip] test range. A non-trip loop test is confirmed on the display with the  symbol

Testing:

1. Connect the mains plug test lead to the instrument.
2. Insert the plug into an installation socket.
3. Supply voltage is displayed.
4. Press the [TEST] key.
5. After a test period of up to 20 seconds the measured loop value is displayed.

If desired the test can be repeated by pressing [TEST] again.

Using the three wire lead set

The [No Trip] loop test can be carried out where a power socket is not available using the three wire lead set.

1. Connect the RED lead to Phase, BLACK lead to neutral and GREEN lead to earth.

2. Supply voltage is displayed.
3. Press the [TEST] key.
4. After a test period of up to 20 seconds the measured loop value is displayed.

Hi current loop test [Hi] LRCD220 only

The [Hi] Loop test performs a 2-wire loop test, provides a rapid loop test, designed for non-RCD protected circuits.

Note: During all [Hi] tests the BLACK neutral test lead should be connected to the same connection point as the GREEN earth test lead.

Range selection:

1. Set the instrument to the [Hi] Loop test range. A Hi current loop test is confirmed on the display with the symbol , which indicates the possibility of tripping an RCD if fitted.

Phase-Earth loop impedance (not at a power socket)

Testing:

1. Connect the Red/Green lead set or the 3-wire test lead to the instrument.
2. Connect the RED [L1] lead to PHASE and the GREEN [L0] lead to EARTH (Black lead - connect the Black lead to the Green lead)
3. The supply voltage is displayed.
4. Press the [TEST] button to start a loop test.
5. After a short delay the measured loop value is displayed.

If desired the test can be repeated by pressing the [TEST] button.

Bonded Metalwork Testing

Repeat the above test but with the Green lead connected to the exposed metalwork.

For a Hi Current Phase to Earth loop impedance measurement at a power socket, repeat the above test using the Mains plug test lead supplied.

Phase-Neutral or Phase-Phase loop impedance

1. Connect the 3-wire test lead to the instrument.
2. Connect the RED [L1] lead to PHASE. Connect the GREEN [L0] lead and the BLACK lead (Black lead - ensure the black lead is connected to the green lead) to NEUTRAL (or the 2nd PHASE for Phase to Phase loop measurement on the LRCD220).
3. The supply voltage is displayed.
4. Press the [TEST] button to start a loop test.
5. After a short delay the measured loop value is displayed. If desired the test can be repeated by pressing the [TEST] button again.

Note: Phase – Phase (415 V) loop test is only possible on the LRCD220.

Prospective Fault Current display [PFC]

1. On completion of a test, press the [PFC] key.
2. The prospective fault current is displayed in Amps or kA.

Notes:

The prospective short circuit current (PSCC) of a circuit is the largest Prospective Fault Current (PFC). In a single phase system, this would be the larger of the earth loop PFC and the neutral loop PFC. In a multi-phase system phase-phase loops also need to be considered and these can be measured using the (Hi) switch position.

The PFC is calculated by using the sum:-

$$\text{PFC} = \frac{\text{Nominal supply voltage}}{\text{Loop resistance}}$$

The supply voltage used in the calculation depends on the measured voltage. The instrument uses the following voltage values:-

Actual measured voltage	Nominal voltage
>80 V and <150 V	110 V (LRCD220 only)
>150 V and <300 V	230 V
>300 V	400 V (LRCD220 only)

PFC measurement accuracy

An accurate PFC measurement requires an accurate measurement of the loop resistance. The difference of a few digits in the loop resistance measured will have a large effect on the PFC displayed.

Warning messages

Noise Indication



The symbol  is displayed when excessive noise caused by other equipment exists on the circuit under test. This noise can affect the accuracy of the loop measurement.

The operator is advised to repeat the measurement or, if the noise symbol continually appears, investigate the cause.

Voltages greater than 280V [>480V on LRCD220]

LRCD200/210: If a voltage greater than 280 V is detected, the display will show >280 V.

RESIDUAL CURRENT DEVICE [RCD] TESTING

LRCD220: If a voltage greater than 480 V is detected between phases the display will show >480 V.

Over temperature hot

To protect the instrument from over heating during Loop testing, thermal protection is fitted. If the message **[hot]** appears in the display together with the  symbol when loop testing, the instrument must be allowed to cool down before further attempts are made at loop testing.

Possible sources of error

The reading depends on a measurement of the supply voltage and therefore noise or transients caused by other equipment during the test could cause an error in the reading. One way to check for these is to do two tests and look for any difference in value. The instrument will detect some sources of noise and warn the user, where other instruments may give an incorrect reading. Any leakage current as a consequence of other appliances connected to the supply under test may affect the reading. If the Phase-Earth loop is being measured, this leakage may be due to filter capacitors, etc.

Test results may be adversely affected by supply voltage fluctuations or electrical 'noise' during a measurement. It is recommended that tests are repeated and the results verified, if measurement results are considered abnormal.

Errors can be reduced by:-

- Use the 2 wire lead set with prods and making a firm connection to clean conductors.
- Make several tests and taking the average.
- Ensure that potential sources of noise in the installation are isolated (switched off), eg: automatically switched loads or motor controllers
- Ensuring that the instrument is calibrated.

Method of measurement

The plug ended test lead or 3 wire lead should be used for these measurements. A constant current source is connected across the supply and the time taken for the supply to trip is measured by the instrument in milliseconds (ms).

The LRCD200, LRCD210 and LRCD220 - can perform the following RCD tests:

- | | |
|------------------|---|
| Type | The RCD type is selectable from, AC, AC Selective, DC and DC Selective. |
| 1/2I | Non-tripping test at half the rated RCD trip current for 2 seconds, during which the RCD should not trip. (NOT LRCD200) |
| I | Tripping test at the rated RCD trip current started on zero crossing of the positive half cycle. The trip time will be displayed |
| 5I | Tripping test at 5 x the rated RCD trip current. The trip time will be displayed in milliseconds. (NOT LRCD200) |
| 0 or 180° | Some RCDs are sensitive to the polarity of the supply, i.e whether the test current is applied on the instantaneous rising or falling part of the supply cycle. Tests should therefore be performed at 0° and 180° and the maximum time recorded. |
| Auto test | Automatically tests 1/2I, I and 5I at 0° at 180°. |
| RampTest | Used to check the trip current of an RCD. |

RCD type selection

To select the RCD type to be tested:

1. Set the top RCD selection knob (top knob) to the desired RCD current range.
2. Set the RCD test knob (lower knob) to 1/2I, I or 5I as required.
3. Press the [TYPE] button to select the type of RCD under test:

Options are:

- AC Standard (displays 'AC') (Default)
- AC Selective (displays 'AC.S')
- DC Sensitive (displays 'dc')
- DC Selective (displays 'dc.S')

1/2I RCD (Non-tripping) measurement (LRCD210 and 220)

To test the tripping time of the installed RCD under test:

Range selection:

1. Connect the mains plug or test lead 3-wire Red/Green/Black test lead to the instrument.
2. Plug in the mains plug test lead to the wall outlet, or the 3 wire test lead across the RCD (refer to connection drawing, go to page 10), also ensure the Black lead is connected to earth.
3. Set the top RCD selection knob to the correct range for the RCD under test.
4. Set the bottom range knob to [1/2I]. The RCD trip indicator will display a closed symbol .
5. Ensure the display shows the mains voltage.
6. Press the [TEST] button. The instrument should display >1999ms and

the RCD should NOT trip.

7. Refer to the application note on Touch Voltage at the end of this section.

NOTE: If the RCD should trip while performing a 1/2I test the error message 'trP' will be displayed instead of the time display.

1xI RCD trip time measurement

To test the [1xI] trip time of the installed RCD:

1. Repeat the previous test for 1/2I, but with the bottom range knob set to I. The RCD trip indicator will display an open symbol .
2. The instrument should display the RCD trip time in milliseconds.

If the display shows >300 ms the RCD has failed to trip in the appropriate time. Check your test lead connections to the RCD and repeat the test.

If the RCD still fails to trip, suspect a faulty RCD.

Note: See also 0°/180° testing below.

The RCD test may abort with ">25 V" or ">50 V" depending on touch voltage setting message if the loop resistance is so high that the test cannot proceed.

5xI RCD trip time measurement

1. Repeat the previous test for 1/2I, but with the bottom range knob set to 5xI. The RCD trip indicator should display an open symbol .
2. The instrument should display the RCD trip time in milliseconds.

If the display shows >40 ms the RCD has failed to trip in the appropriate time. Check your test lead connections to the RCD and repeat the test.

If the RCD still fails to trip, suspect a faulty RCD.

NOTE: The current limit for the 5I test is 100 mA, as the test current available is limited to 1 Amp.

0° or 180° testing

Both the [1 x I] and [5 x I] tests should be performed for 0° and 180°.

Repeat the 1 x I and 5 x I tests as above but with the instrument set to 180°.

0° or 180° is selected by pressing the [0°/180°] and the greatest trip time for each test should be recorded.

RampTest (LRCD220 only)

The RCD trip current is measured by applying a test current of half the rated trip current and increasing this every 200 ms. When the RCD trips, the current flowing is recorded and displayed in mA.

1. Select the appropriate RCD rated current on the top range knob.
2. Select the RAMP  test on the lower range knob.
3. Press the [TEST] test button
4. The RCD should trip and the trip current will be displayed.
5. If the RCD fails to trip, >***mA is displayed where *** mA indicates the maximum RCD tripping current allowed and will vary depending on range selected.

DC Sensitive RCD test [RCD]

D.C. sensitive RCDs are tested as per standard RCDs. The RMS current used is $\sqrt{2}$ x the rated operating current of the RCD.

As with the normal RCDs, these should be tested at 0° and 180°, or in the case of DC sensitive RCDs, positive and negative.

Possible sources of error

Measurement results can be affected by the following:

1. Significant operating errors can occur if loads, particularly rotating machinery and capacitive loads are left connected during tests.
2. A poor connection to the circuit under test.

AUTO RCD TEST

AUTO test will run the 1/2I, I & 5I plus 0° and 180° tests automatically. The operator can stand by the RCD to reset it when it trips on the I & 5I tests.

1. Connect to the circuit as per the 1/2I test.
2. Select the RCD current rating on the top range knob and the AUTO function on the lower range knob.
3. Press the TEST button to start the test. The lock symbol will flash to indicate a AUTO test sequence is running, and the display will show 't1' to 't5' to indicate which test is running.
t1 = 1/2I, t2 = I at 0°, t3=I at 180°, t4= 5I at 0° and t5= 5I at 180°
4. Reset the RCD each time it trips.
5. On completion of testing the results can be recalled by repeatedly pressing the 0°/180° button.

To indicate each test result, segments of the bar graph are displayed as below:

none = 1/2I test

I = 1xI test

IIIII = 5 I test

Example shows 5I on 0°

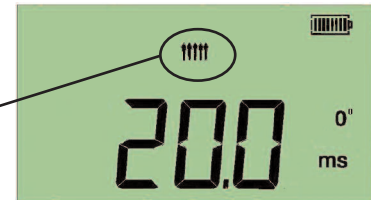

VOLTAGE MEASUREMENT

When connected to a system using the three wire lead set or mains plug the instrument indicates the greatest voltage on the system.

Phase to Earth voltage measurement

Note: measured voltage must not exceed 300 V phase to earth.

To measure the voltage of the electrical supply:

1. Set the instrument to the [V] range.
2. Connect the GREEN or (L0) lead to the protective Earth (PE) and the RED or (L1) lead to the phase to be measured.
3. The instrument will display the phase to earth voltage.

Touch Voltage

On all Megger LRCD200 series testers, the touch voltage is calculated at the start of an RCD test to ensure it will remain below the safe 25 V or 50 V limit as required by the application.

On the LRCD200 series instruments, the touch voltage limit can be switched from 50 V to 25 V as the application demands.

Should the touch voltage calculation identify a higher touch voltage than that permitted, the LRCD tester will stop the test, thus preventing the presence of an unsafe voltage on the earth during the test, should the test have taken place.

For those customers that require the touch voltage to be displayed, this can be displayed by activating the analogue arc display, as described in the instrument set-up procedure.

Once activated the touch voltage will be displayed on an RCD test, even if the voltage is below the permitted limits.

FREQUENCY Hz

To measure the frequency of the electrical supply:

1. Set the instrument to the [Hz] range.
2. Connect the GREEN or (L0) lead to the protective Earth (PE) and the RED or (L1) lead to the phase to be measured.
3. The instrument will display the frequency in Hz.

PHASE SEQUENCE (LRCD 220 ONLY)

When connected to all conductors of a three phase system, the instrument automatically displays the sequence of phase rotation.

To determine phase sequence

1. Connect the Installation Testers as follows:-

Line 1 Red lead to Red phase

Line 2 Green lead to Yellow phase

Line 3 Black lead to Blue phase

2. The symbol is displayed will show the phase sequence:

 indicates RD (BN) – BU (GY) – YE (BK) sequence (or 1:2:3)

 indicates RD (BN) – YE (BK) – BU (GY) sequence (or 1:3:2)

Note: If one of the lines is faulty, neither of the symbols is displayed and just the normal 'neon' polarity indication is shown.

AUTO POWER DOWN

To extend battery life the instrument will automatically switch off six minutes after the last operation.

The instrument can be switched off manually by selecting [OFF] with the rotary switch, or switched back on again by pressing the [TEST] button.

Messages for information and warnings

RCD test types

AC	AC type
AC.S	AC Selective RCD
DC	DC type RCD
DC.S	DC Selective RCD

Warnings

trp	Unexpected disconnection
hot	Overheated instrument
chk	Check test lead connections
noS	Noise
>50V	Touch voltage exceeded (for 50V settings)
>25V	Touch voltage exceeded (for 25V setting)
<***V	Insufficient supply voltage for test



Other messages

L + L	Will test with L/N swapped
L + N	Will NOT test with L/N swapped
SEt	Setup menu
OFF	Instrument is about to switch off

REPLACING BATTERIES AND FUSES

Battery type: 8 x LR6 (AA), 1.5 V Alkaline, or 8 x 1.2V NiCAD, or 8 x 1.2V NiMH

Low battery warning symbol

The battery condition is continuously displayed by the symbol . When the batteries are exhausted, symbol will show  and the instrument switches off. Batteries should be replaced when 2 bars are displayed.

If the symbol appears as less than fully charged with new batteries fitted, check for correct polarity.

Note: Fully charged NiMH or NiCAD rechargeable batteries show a lower charge than Alkaline batteries, and may not give much warning before becoming exhausted.

To replace batteries

Warning: Do not switch the instrument on with the battery cover removed.

1. Switch off the instrument and disconnect (the instrument) from any electrical circuits.
2. The rear cover must not be opened if the test leads are connected.
3. To remove the rear cover release the screw at the bottom of the cover and lift the cover upwards.
4. Fit new batteries observing the correct polarity as marked on the battery compartment.
5. Replace the cover.

Warning: - Incorrect battery cell polarity can cause electrolyte leakage, resulting in damage to the instrument.

Check that the Battery level indicator displays a full charge before using the instrument. A low battery charge may indicate a reversed cell.

Note: Battery cells should not be left in an instrument which may remain unused for extended periods of time.

Fuse Blown indication

The fuse blown symbol  indicates that an internal fuse has failed. This instrument is fitted with a factory fitted fuse and should only be replaced by an authorised Megger repair centre.

To extend battery life the instrument will automatically switch off six minutes after the last operation.

The instrument can be switched off manually by selecting [OFF] with the rotary switch, or switched back on again by pressing the [TEST] button.

PREVENTIVE MAINTENANCE

Clean only with a damp cloth. Do not use any alcohol based cleaning fluids as they may leave a residue.

TECHNICAL SPECIFICATION

Voltage measurement:

(LRCD200, 210, 220):

0 V - 500 V

Accuracy:

$\pm 2\%$ ± 2 digits

Frequency measurement:

(LRCD200, 210, 220)

Range:

25Hz to 450Hz

Accuracy:

25.0Hz to 199.9Hz ± 0.1 Hz

200Hz to 450Hz ± 1 Hz

Phase rotation indicator

(LRCD220 only)

Three wire identification of phase rotation.

Loop testing:

Loop ranges (to EN 61557-3)

(LRCD200, 210, 220)

No Trip Loop test 3-wire (Line to Earth)

Supply:

LRCD200/210 200 V - 280 V 45Hz to 65Hz

LRCD220 100 V - 280 V 45Hz to 65Hz

Nominal test current:

15 mA

Loop Accuracy:

0.01Ω - 9.99 Ω (±5% ±0.03 Ω)

10.0Ω - 99.9 Ω (±5% ±0.5 Ω)

100Ω - 999 Ω (±5% ±5 Ω)

1.00 kΩ - 2.00 kΩ (±5% ±30 Ω)

HI current Line/Earth loop test 2 wire (LRCD220 only)**Supply:**

100 V - 480 V

Nominal Test Current:

15 mA to 2.4 A

Loop accuracy:

0.01Ω - 9.99 Ω (±5% ±0.03 Ω)

10.0Ω - 99.9 Ω (±5% ±0.5 Ω)

100Ω - 999 Ω (±5% ±5 Ω)

1.0 kΩ - 2.00 kΩ (±5% ±30 Ω)

Line/Line (LRCD220 only)**Supply:**

100 V - 480 V 45Hz to 65Hz

Prospective Fault Current (PSCC)

Prospective fault current = Nominal supply voltage/Loop resistance

Accuracy is derived from loop test

1 A - 199 A 1 A resolution

0.20 kA - 1.99 kA 10 A resolution

2.0 kA - 19.9 kA 100 A resolution

RCD Testing

RCD Test Ranges (to EN61557-6)

LRCD200/210 10 mA, 30 mA, 100 mA, 300 mA, 500 mA

LRCD220 10 mA, 30 mA, 100 mA, 300 mA, 500 mA, 1000 mA

Supply voltage:

LRCD200/210 = 200 V - 280 V 45Hz to 65 Hz

LRCD220 = 100 V - 280 V 45Hz to 65 Hz

Test Current Accuracy:**No Trip Test:**

(1/2I) -8% to -2%

Trip Test:

(I, 5I) +2% to +8%

Trip Time:

±1% ±1ms

Fault (Touch) Voltage**Displayed range:**

0 V to 50 V

Error:

+5%/+15% ±0.5 V

Temperature and humidity

Operating Range:

-5°C to +40°C

Operating Humidity:

93% R.H. at +40°C max.

Storage Range:

-25°C to +70°C

Maximum altitude:

2000m

Environmental Protection:

IP54

Safety

IEC 61010

Meets the requirements of IEC61010-1 Cat III 300V phase to earth.

EN61557

Complies with the following parts of EN61557, Electrical safety in low voltage systems up to 1000 V ac and 1500 V dc- Equipment for testing, measuring or monitoring of protective measures:

Part1- General requirements

Part3- Loop resistance

Part6- Residual current devices

Power supply

Battery: 8 x 1,5 V cells IEC LR6 type (AA alkaline).

Rechargeable: 8 x 1.2V NiCd or NiMH cells.

Battery Life: 2000 consecutive tests

Weight: All units 980gms

Dimensions: All units 203 x 148 x 78 mm

E.M.C.

In accordance with IEC61326-1

Operational inaccuracies: Refer to www.megger.com

BASIC AND SERVICE ERRORS

Basic and service errors loop test ranges

The basic error is the maximum inaccuracy of the instrument under ideal conditions, whereas the service error is the maximum inaccuracy taking into effect of battery voltage, temperature, interference, and system voltage and frequency, where applicable.

ACCESSORIES

Item	Order Code
3 wire test lead set and crocodile clips	6220-782
Mains plug test lead (BS 1363) (BS Versions)	6220-740
Mains plug test lead CEE 7/7 (EN versions)	6220-741
Mains plug test lead (AS/NZS 3112) (AU versions)	6220-790
Quick start guide	5174-208
Megger certification software	
PowerSuite Pro-Lite 16th	6111-695

REPAIR AND WARRANTY

The instrument contains static sensitive devices, and care must be taken in handling the printed circuit board. If an instrument's protection has been impaired it should not be used, but sent for repair by suitably trained and qualified personnel. The protection is likely to be impaired if for example; it shows visible damage; fails to perform the intended measurements; has been subjected to prolonged storage under unfavourable conditions, or has been subjected to severe transport stresses.

NEW INSTRUMENTS ARE GUARANTEED FOR 3 YEARS FROM THE DATE OF PURCHASE BY THE USER.

Note: Any unauthorized prior repair or adjustment will automatically invalidate the Warranty.

INSTRUMENT REPAIR AND SPARE PARTS

For service requirements for Megger Instruments **contact:**

Megger Limited	or	Megger
Archcliffe Road		Valley Forge Corporate Centre
Dover		2621 Van Buren Avenue
Kent CT17 9EN		Norristown PA 19403
England.		U.S.A.

Tel: +44 (0) 1304 502 243 Tel: +1 610 676 8579

Fax: +44 (0) 1304 207 342 Fax: +1 610 676 8625

or an approved repair company.

UKrepairs@megger.com

Returning and Instrument for Repair

If it is necessary to return an instrument for repair, a returns authorisation number must first be obtained by contacting one of the addresses shown. You will be asked to provide key information, such as the instrument serial number and fault reported, before the number is issued. This will enable the Service Department to prepare in advance for the receipt of your instrument, and to provide the best possible service to you.

The returns authorisation number should be clearly marked on the outside of the product packaging, and on any related correspondence. The instrument should be sent, freight paid to the appropriate address. If appropriate a copies of the original purchase invoice and of the packing note, should be sent simultaneously by airmail to expedite clearance through customs.

For instruments requiring repair outside the warranty period a repair estimate will be submitted to the sender, if required, before work on the instrument commences.

Approved Repair Companies

A number of independent instrument repair companies have been authorised for repair work on most Megger instruments, using genuine Megger spare parts. A list of approved companies is available from the UK address shown on this page. Spare parts are also available.







Megger Limited
Archcliffe Road, Dover
Kent CT17 9EN England
T +44 (0)1 304 502101
F +44 (0)1 304 207342
E uksales@megger.com

Megger
4271 Bronze Way, Dallas,
Texas 75237-1019 USA
T +1 800 723 2861 (USA ONLY)
T +1 214 333 3201
F +1 214 331 7399
E ussales@megger.com

Megger
Z.A. Du Buisson de la Coudre
23 rue Eugène Henaff
78190 TRAPPES France
T +33 (0)1 30.16.08.90
F +33 (0)1 34.61.23.77
E infos@megger.com

Megger Pty Limited
Unit 26 9 Hudson Avenue
Castle Hill
Sydney NSW 2125 Australia
T +61 (0)2 9659 2005
F +61 (0)2 9659 2201
E ausales@megger.com

Megger Limited
110 Milner Avenue Unit 1
Scarborough Ontario M1S 3R2
Canada
T +1 416 298 9688 (Canada only)
T +1 416 298 6770
F +1 416 298 0848
E casales@megger.com

Megger products are distributed in 146 countries worldwide.

This instrument is manufactured in the United Kingdom.
The company reserves the right to change the specification or design without prior notice.

Megger is a registered trademark

Part No. LRCD200_UG_en_V08 0909
www.megger.com