

Multi-Function Installation Tester

MEGGER CM500

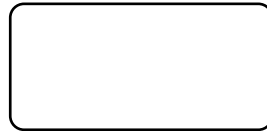

User Guide



MEGGER®



SAFETY WARNINGS

- Q **Safety Warnings** and **Precautions** must be read and understood before the instrument is used. They **must** be observed during use.
- Q The circuit under test must be switched off, de-energised and isolated **before** test connections are made when carrying out insulation and continuity tests.
- Q Continuity of protective conductors and earthed equipotential bonding of new or modified installations **must** be verified **before** carrying out an earth fault loop impedance test, or RCD test.
- Q Circuit connections and exposed metalwork of an installation or equipment under test **must not** be touched.
- Q **Do not move** the rotary selector switch position while a test is in progress.
- Q The LCD 'neon' voltage indicators **cannot** reveal a Neutral - Earth reversal.
- Q After insulation tests, capacitive circuits must be allowed to discharge **before** disconnecting test leads.
- Q The instrument should **not** be used if any part of it is damaged.
- Q Test leads, probes and crocodile clips must be in good order, clean and with no broken or cracked insulation.
- Q U.K. Safety Authorities recommend the use of fused test leads when measuring voltage on high energy systems.
- Q Replacement fuses **must** be of the correct type and rating.

NOTE

THE INSTRUMENT MUST ONLY BE USED BY SUITABLY TRAINED AND COMPETENT PERSONS

Initial Setup

Read this page before using the *CM500*.

Your *CM500* has been set up as shown on the label on the front of this User Guide:-

The **first line** gives the setting, which modifies the way the instrument behaves.

	Setting A (Europe)	Setting b (UK)
Continuity tests	2 reversing current measurements are made	Single measurement made
RCD, Loop and Earth tests	Line and Neutral swap allowed	Line and Neutral swap not allowed
RCD tests	Auto RCD does 5I test	Auto RCD does 150 mA test
	After trip test contact voltage displayed first.	After trip test, trip time or current displayed first
	2s ½ No Trip test not performed	2s ½ No Trip test performed

The second line gives the printer report language. This may be Language 1, which is English, or Language 2 which is the language noted on the third line of the label.

Instrument Setup

The instrument setup mode allows you to change the setting, the printer speed and the printer report language.

To display the current setup modes:-

1. Press and hold the **backlight**  key, then turn the rotary selector switch from the from 'OFF' position to the 'RCL' position. The code **PdE** (printer speed) is displayed.

2. Release the **backlight**  key.
3. Toggle the **I** key to scroll through and display the current setup modes. as follows:-

Code	Item	Meaning
PdE	Printer speed	Delay after each line. Change from 0,0 to 10,0 seconds
LNg	Printer report language	Language 1 is English. Language 2 can be changed using the CM500 Setup disk supplied.
SEt	Setting	Described in detail opposite, Setting A is for Continental Europe, Setting b is for the U.K.

To change the Printer speed

1. Toggle the **I** key to scroll through and display the **PdE** code.
2. Press the **SAVE** key. The current speed setting is displayed.
3. Toggle the **RCL** keys until the required speed setting is displayed.
4. To save the new setting, press the **SAVE** key. The bleeper sounds and **PdE** is displayed. To abort the new setting, press the **EXIT** key. **PdE** is displayed.

To select the Printer language

1. Toggle the **I** key to scroll through and display the **LNg** code.

-
2. Press the **SAVE** key. The current printer report language is displayed as **1** (English) or **2** (as given on the type label on the previous page).

Note:- Language **2** can be changed using the *CM500* Setup Disk supplied.

3. Toggle the **I** key until the required language setting is displayed.
4. To save the new setting, press the **SAVE** key. The bleeper sounds and **LRG** is displayed. To abort the new setting, press the **EXIT** key. **LRG** is displayed.

To select the Setting

1. Toggle the **I** key to scroll through and display the **5Et** code.
2. Press the **SAVE** key. The current setting is displayed as **A** (Continental Europe) or **b** (U.K.).
3. Toggle the **I** key until the required setting is displayed.
4. To save the new setting, press the **SAVE** key. The bleeper sounds and **5Et** is displayed. To abort the new setting, press the **EXIT** key. **5Et** is displayed.

CM500 Setup Disk

The program on the disk enables the second printer language to be changed into any of the separate languages. The program may be run directly from disk. Connect the PC to the instrument via a serial lead.

for DOS type: **a:\cm500set** and press: **Return.**

for Windows™ 3.1 or 3.11:

1. From the **Program Manager** options, select: **File**
2. From the options given, select: **Run.**
3. Type: **a:\cm500set** and press: **Return.**

For Windows™ 95:

1. Select the **Start** menu.
2. Select the **Run** option.
3. Type: **a:\cm500set** and press: **Return.**

Follow the instructions given by the program.

General Description

The *MEGGER CM500* Multi-function Installation Tester is a compact instrument designed to perform all of the functions required by the electrical contractor to fully test domestic, commercial and industrial wiring. Specially designed to comply with U.K., European and other International wiring regulations and standards, the *CM500* may be used on all single and three phase systems with rated voltages up to 300 Volts a.c. rms to earth/ground.

Measured values are indicated on a large backlit analogue/digital LCD and may also be stored in internal memory for later recall to the display, direct printing via a standard serial printer, or downloaded to a PC for storage, analysis and report generation.

The *CM500* is supplied as standard in a protective test and carry case, and with the necessary mains plug lead and 2-wire lead set required to commence testing. Optional accessories include the *SP2*, a 2-wire lead set with test switch built into one of the probes providing remote operation, and a 5 metre 2-wire lead set for increased accessibility.

Key Features

- No Trip loop Impedance test
- Storage of test results in memory
- Direct serial printer driver output
- RS-232 Output for PC storage
- Recall stored results to the display
- RCD Ramp test function
- Analogue arc and digital display.
- Selectable backlight
- Optional switchable probe (*SP2*)

Test Capability

- **Insulation**
 - Test voltages of 250V, 500V and 1000V.
- **Continuity testing**
 - Fast bleeper
 - Test lead resistance nulling
 - Automatic polarity reversal (**Setting A**)
- **Loop Testing**
 - Operates regardless of mains polarity (**Setting A**)
 - Two wires only needed for testing
 - Automatic test start on voltage detection
 - Direct indication of short circuit current.
 - Phase - phase, phase - neutral & phase - earth tests
 - Simple earth electrode test
- **RCD Tests**
 - Tests selective (delayed) general and d.c. sensitive RCDs.
 - Two wires only needed for testing
 - Contact voltage and loop resistance displayed.
 - Selectable test current for programmable devices
- **Supply voltage and frequency measurement**
- **Phase sequence indication**
- **Mains outlet polarity indication**

Application

The *CM500* may be connected live to earth or between live conductors of systems that have a rated voltage of 300V a.c. rms to earth and an installation (overvoltage) Category III or lower. This means that the *CM500* may be connected to any fixed wiring of a building installation, but not to primary supply circuits such as overhead cables. To maintain user safety and ensure accurate measurements, only use the test leads supplied or

recommended for use with this instrument.

The *CM500* is fuse protected to 440V 10kA. The maximum current which could flow through this fuse in the case of a fault is limited to 10 kA by the impedance of the test leads. There is a fuse accessible in the battery compartment which protects the Insulation and Continuity range. If warning of a ruptured fuse is given during a test, and if the warning symbol is present when attempting to carry out an insulation test with the test leads shorted together, this fuse must be replaced by another fuse of the same type and rating i.e. 500 mA (F) 500 V H.B.C. 10 kA.

Fuse Replacement

To replace the fuse, **disconnect the test leads**, switch the instrument Off and with a screwdriver, loosen the captive screw holding the battery compartment cover in place. Remove the cover. Depress the fuseholder slightly, and turn a quarter turn anti-clockwise to release. Remove the holder and replace the fuse with one of the correct size and rating. Relocate the fuse holder, depress and turn a quarter turn clockwise. Replace and re-secure the cover.

Battery Replacement

When the low battery symbol  appears, the cells are nearly exhausted and should be replaced as soon as possible. When the battery is exhausted, the instrument will not perform tests and the cells must be replaced. Use Alkaline cells IEC LR6 (AA) or 1,5 V nickel cadmium cells only.

To install or replace the cells, **disconnect the test leads**, switch the instrument Off and loosen the captive screw holding the battery compartment cover in place. Remove the cover, lift out and disconnect the battery holder to access the cells. Ensure that the replacement cells are fitted with the correct polarity, in

accordance with the symbols on the battery holder moulding.



Incorrect battery cell polarity can cause electrolyte leakage, resulting in damage to the instrument.

Carefully re-connect the battery holder to the plug, replace the battery holder in the compartment, and re-secure the cover. Remove the cells if the instrument is not going to be used for any extended period of time. Stored results are retained when the battery is disconnected.

Test Leads

All test leads form part of the measuring circuit of the instrument and must not be modified or changed in any way, or be used with any other electrical instrument or appliance. The power cord supplied with the *CM500* is a test lead that forms part of the measuring circuit of the instrument. The overall length of this lead must not be altered. If the power cord plug is not suitable for your type of socket outlets, do not use an adaptor. You may change the plug once only by cutting the cord as close to the plug as possible and fitting a suitable plug.

The colour code of the cord is:

Earth (Ground)	Yellow/Green
Neutral	Blue
Phase (Line)	Brown

Note: A plug severed from the power cord must be destroyed, as a plug with bare conductors is hazardous in a live socket outlet.

Features, Controls and Connections

Auto Shut-off
Operates after 5 minutes of inactivity by the instrument (30 seconds in Bleeper mode)



Press I and TYPE key to:

- Select test parameters
- Enter test result identification

Press TYPE key to:

- Select test voltage (MΩ)
- Select type of RCD
- Delete data (in combination with I key)

Push TEST button to:

- Initiate the selected test
- Repeat selected test

Touch finger to Earth Test Pad to:

- Check potential between the Earth connection and your finger

150mA 40ms test selection

RCD test selection

VAR test selection

Loop test selection

Press key to:

- Display other test results

Press and hold key to:

- Save test results

Backlight key

'OFF' position

Recall / Download position

Continuity test position

Lead resistance null position

Continuity Bleeper position

Insulation test positions

Turn Rotary Selector Switch to:

- Select test position
- Select Download (RCL)
- Select 'OFF'

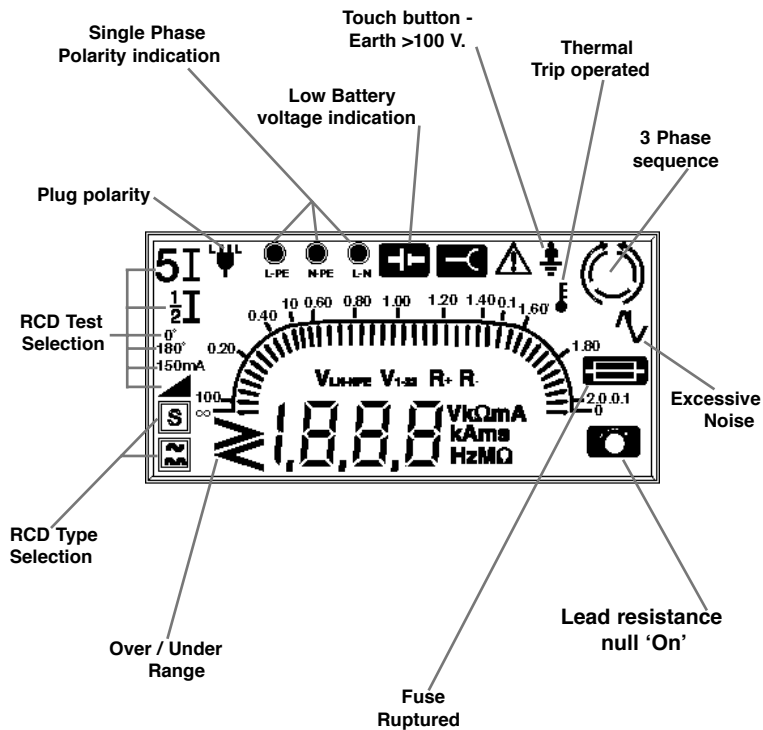

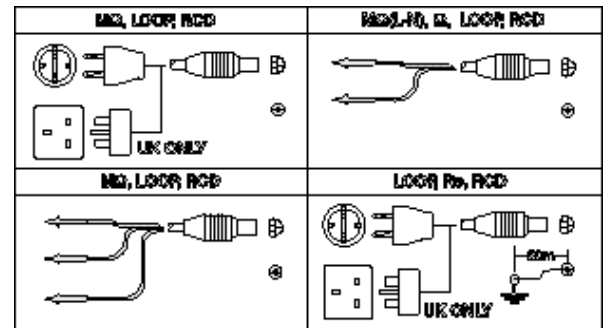

CM500_Display



CM500_Connections

Operation

Backlight

The display backlight gives a clear display of measurements in poor lighting conditions. The backlight will briefly operate when the *CM500* is switched on. To switch the backlight on, press the  key. Press the  key again to switch the backlight off. To conserve battery power, the backlight will automatically switch off after a period of 15 seconds (if the battery voltage is low, this period is automatically reduced).

Auto Shut - Off

To extend battery life and reduce unnecessary drainage, the *CM500* uses advanced battery management techniques, switching functions off when they are not required. For example, if an external voltage of 25 V or less is applied, no value is displayed unless the backlight is switched on. After a period of inactivity by the instrument, the *CM500* will switch itself off, preceded by a series of beeps. To switch the instrument back on, press any key.

Switched Probe SP2

This is an accessory which can be used anywhere that the 2-wire lead set is specified in this User Guide. The press button probe duplicates the function of the **TEST** key on the instrument, allowing quick and easy testing.





The *SP2* probe test key circuit is hazardous live during a test. It is safe in normal use.

Continuity of the *SP2* probe non replaceable fuse must be confirmed (by testing in the Bleeper range) before making any measurement.

Checking Earth Potential

To quickly distinguish live and earth, this feature provides display indication if a voltage greater than 100 V exists between the earth connection and your finger.

1. In any switch position except **OFF**, **RCL** and (Ω) , connect the earth connection (black for the 2-wire lead set, green for the 3-wire lead set) to earth.
2. Touch a finger to the metal pad on the front panel. This is safe and will not endanger you.
3. If a voltage greater than 100 V exists between the finger (normally at earth potential) and the earth wire, the warning symbol  is displayed.

Voltage and Frequency Measurement

The *CM500* will display the supply voltage and frequency in all switch positions except (Ω) , **RCL** and **OFF**. The **DISPLAY** key will alternate between voltage and frequency.

Power plug connection

1. Insert the power cord plug into an installation socket.
2. Supply voltage and polarity are displayed.
3. Press **DISPLAY** to alternate between supply voltage and frequency.

2-wire lead set connection

If an installation socket is not available, use the 2-wire lead set.

1. Connect the red and black leads to the two conductors to be tested.
2. Voltage between the leads and polarity are displayed.

Note:- Though displayed, when using the 2-wire test set, 'neon'

indication is invalid and should be ignored.

- Press **DISPLAY** to alternate between supply voltage and frequency.



3-wire lead set connection

If an installation socket is not available and it is necessary to connect to all three conductors, use the 3-wire lead set.

- On a single phase system connect the red lead to phase, the black to neutral and the green to earth.
- Supply voltage and polarity are displayed.
- Press **DISPLAY** to alternate between supply voltage and frequency.

Note: For connection to a three phase system, see 'Determining Phase Sequence'.

When connected, the instrument will display the supply voltage indicated in the following table:

Mode	Switch Position	Voltage Display
RCD Tests (all Currents)	(RCD) positions	L-PE
Loop Resistance	(Loop) L-L/L-N	L-N
	(Loop) L-PE/Re	L-PE
Continuity	(Ω) R	L-N
	(Ω) 	L-N
	(Ω) 	L-N
Insulation	(M Ω) L-PE	L-PE
	(M Ω) L-N	L-N
	(M Ω) N-PE	N-PE
Download to PC	RCL	No Display
Off	Off	





















Polarity Indication

If connected to a single phase power supply by a plug or by the 3-wire lead set, three LCD 'neons' marked **L-PE**, **N-PE** and **L-N** respectively will indicate supply polarity. If a voltage is detected between their respective two wires, the 'neon' will activate. A 'neon' will usually flash if one connection is open circuit.

Note:- The presence of a voltage between phase and earth does not prove earth continuity, as the earth could have a high resistance and a voltage would still be measured. To test earth continuity refer to the sections on loop resistance or RCD testing.

If **Setting A** is set, the *CM500* will automatically switch Line and Neutral as appropriate, when in any of **LOOP**, **Re** (earth) or **RCD** test functions. This enables a test to be performed without inverting the plug connections. The live terminal of the wall socket is identified by the addition of a separate symbol  adjacent to the 'neons'.

The Phase / Neutral reversal and symbol display does not occur in **Setting A** Insulation and Continuity ranges, and does not occur in **Setting b**.

	L-PE	N-PE	L-N	
				Normal Supply
				L-N Reversed
				Neutral Live
				Neutral Open Circuit
				Earth Open Circuit

Setting A - LOOP, Re (earth) and RCD

Operation (Contd.)

	L-PE	N-PE	L-N	
				Normal Supply
				Normal Supply
				Neutral Live
				Neutral Open Circuit
				Earth Open Circuit

Setting A - MΩ and Ω, and Setting b

Determining Phase Sequence

When connected to all conductors of a three phase system, the *CM500* automatically displays the sequence of phase rotation.

Connect the *CM500* as follows:-

Line 1	Red phase	Red lead
Line 2	Yellow phase	Green lead
Line 3	Blue phase	Black lead

If connected as above, the symbol is displayed when the sequence is 1:2:3, or Red-Yellow-Blue. The symbol is displayed when the sequence is 1:3:2, or Red-Blue-Yellow. If one of the lines is faulty, neither of the symbols is displayed and the normal 'neon' polarity indication is shown.

To measure the phase to phase voltages, the following switch positions are used:-

Switch position	Voltage Shown	
(MΩ) L-PE	Red and Green Leads	V ₁₋₂
(MΩ) L-N	Red and Black leads	V ₁₋₃
(MΩ) N-PE	Black and Green leads	V ₂₋₃

Continuity Testing, Low Resistance and kΩ Measurement

The *CM500* will measure low resistance from 0.01Ω to 99.9Ω and will automatically change range to kΩ up to 99.9 kΩ using the 2-wire lead set. Up to 10 Ω of test lead resistance may be subtracted using the test lead resistance nulling range. Measurement is displayed on the large digital display, and the analogue scale from 0 Ω to 20 Ω, or 0 to 20 kΩ.

In **Setting A**, automatic polarity reversal is carried out with the *CM500* measuring resistance with both positive and negative current flow. Normally the average of the two results will be displayed.



CM500 will automatically display any voltage over 25 V between the two test leads, and inhibit testing if >5 V.

Test Lead Resistance Nulling

The *CM500* measures total resistance between its terminals, including the resistance of the test leads. The value of the test leads can be automatically nulled.

1. Firmly short the ends of the test leads together.
2. Select (Ω) lead resistance null position.
3. Press the **TEST** key. The test leads are checked.
4. **0.00 Ω** is displayed to confirm that a new lead value has been stored.

This measured lead resistance will be subtracted from all subsequent continuity tests in the **(Ω) R** switch position. Note that this lead nulling will not be lost when the instrument is switched off.

To clear any set nulling, carry out a lead resistance nulling procedure with the leads open circuit.

Low Resistance continuity measurement (Ω) R

1. If required, firmly short test leads together and null their resistance as described above.
2. Select **(Ω) R**.
3. Firmly connect the two wire lead set terminals across the isolated circuit.
4. Press the **TEST** key. The test result is displayed. The symbol  is displayed if lead resistance nulling has been set.

Continuity Bleeper (Ω)

To quickly check continuity of a circuit, the *CM500* bleeper will sound continuously if the resistance between the leads is less than 100 Ω .

Low input resistance voltmeter (Ω)

In switch positions other than **Continuity Bleeper**, the supply voltage is measured with a high input resistance. This can cause misleading readings if cables are open circuit. In the **Continuity Bleeper** position, the input resistance is initially about 1 k Ω . If external voltage is measured at the terminals, the bleeper sounds with a slow intermittent tone, and displays the voltage. This will not damage the instrument, however thermal protective

devices will inhibit immediate use of the Continuity bleeper, for a short period. If the 'hot'  symbol is displayed, confirm the bleeper operation by shorting the test leads and waiting for the normal continuous bleeper tone.

5 Ω Threshold

A lower threshold of 5 Ω can be set by pressing the **TEST** button. When this is set, the bleeper will sound with a fast intermittent tone if the resistance between the leads is between 100 Ω and 5 Ω , and continuously if the resistance is less than 5 Ω . When set to this mode, the 500 mA fuse is used to protect the instrument and may be ruptured by connection to a mains supply.

Method of measurement

The 2-wire lead set must be used for this measurement. A d.c. voltage of nominally 4,5 V with a current limit of approximately 210 mA is used to measure resistance less than about 30 Ω . Higher resistances are measured with a current limit of 2 mA. The first measurement is made with current flowing from the black lead to the red lead, and if **Setting A** has been set, a second measurement will be made with the current reversed.

Possible sources of error

Measurement results can be affected by the following:

- The impedance of operating circuits connected in parallel.
- Impedance such as inductors that vary during the measurement.
- A poor connection to the circuit under test, which can give readings as much as 100 m Ω (0,10 Ω) high. The best way to avoid this error is to use sharp prods and press these firmly into the conductors being measured.

Operation (Contd.)

Insulation Testing and High Resistance Measurement

The *CM500* will test insulation resistance (1 k Ω to 99.9 M Ω) between phase, neutral and earth (ground) as required, at the selected voltage. With a default setting of 500 V d.c., the test voltage can be altered to 250 V, 500 V or 1 kV as required. Measurement is displayed on the large digital display and the analogue scale.



After performing an insulation test, maintain connection to the circuit under test to allow the circuit to discharge. If voltage remains after a test, the *CM500* will normally display this as it is discharged. It must be verified that the test voltage has been discharged before moving onto the next test.

2-wire lead set method

1. Disconnect Phase, Neutral and Earth at the distribution board.
2. Connect the leads across the isolated circuit.
3. Select **(M Ω) L-N**.
4. Press either the **I** or the **TYPE** key to display the test voltage. Press again until the required test voltage is displayed.
5. Press and hold the **TEST** key.
6. Circuit resistance value is displayed.
7. Release the **TEST** key, but maintain connection to allow the test voltage to discharge.

When using the 2-wire lead set to measure insulation, always select **(M Ω) L-N**. The insulation will be measured between the two leads.

3-wire lead set method

Use of a 3-wire lead set enables all combinations of insulation to be tested without changing lead connections.

1. Disconnect Phase, Neutral and Earth from the distribution board.
2. Connect the red lead to Phase; the black lead to Neutral, and the green lead to Earth (ground).
3. Select **(M Ω) L-PE, L-N or N-PE** as required.
4. Press either the **I** or the **TYPE** key to display the test voltage. Press again until the required test voltage is displayed.
5. Press and hold the **TEST** key.
6. Circuit resistance value is displayed.
7. Release the **TEST** button, but maintain connection to allow the test voltage to discharge.

Power plug method

The insulation resistance of an installation may be tested by using the plug terminated test lead at a convenient socket outlet. However:-

- a) The installation must be isolated from the supply.
- b) The insulation test will incorporate the immediate circuit and any other circuit connected on the load side of the distribution board (D.B.).
- c) If a low reading is obtained, each circuit must be individually tested from the distribution board to locate the fault.

1. Disconnect Phase, Neutral and Earth from the D.B.
2. Insert the power plug into an installation socket on the isolated circuit to be tested.
3. Select (**MΩ**) **L-PE**, **L-N** or **N-PE** as required.
4. Press either the **I** or the **TYPE** key to display the test voltage. Press again until the required test voltage is displayed.
5. Press and hold the **TEST** key.
6. Circuit resistance value is displayed.
7. Release the **TEST** button, but maintain connection to allow the test voltage to discharge.

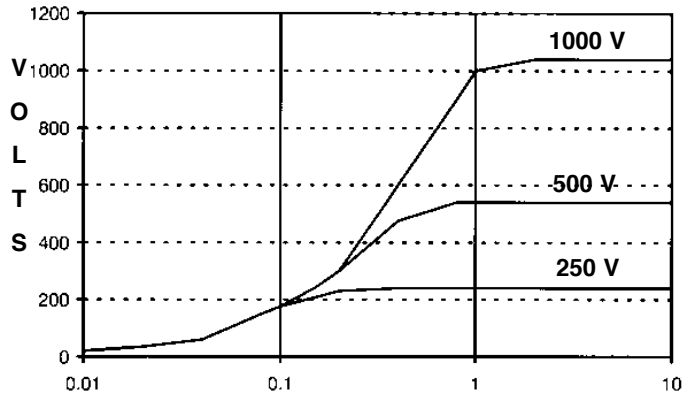

Insulation Test Voltage

Method of measurement

A current limited d.c. source is used, and the resistance is calculated from measurements of the voltage and current. The polarity of this d.c. source is as follows:-

<u>Range</u>	<u>+ve terminal</u>	<u>-ve terminal</u>
L-N	Neutral (Black)	Phase (Red)
N-E	Neutral	Earth
L-E	Phase (Red)	Earth (Black)

The voltage is only present when the test button is pressed. A measurement of the terminal voltage is made before the test and if this exceeds about 25 V the test is disabled. If d.c. voltage is detected across any of the terminals a discharge resistor is connected across it. The reading is stable with a circuit capacitance less than 5 μF.

Loop Impedance measurement

Loop impedance measurement of 0,01Ω up to 3.00 kΩ can be made via installation sockets using the plug terminated test lead, or at any other convenient point on the installation using the two wire lead set. If **Setting A** is selected when using the plug terminated lead set, the polarity of the mains socket is immaterial. Line and Neutral will be swapped if necessary, and an indication given on the display. **Setting b** requires Line and Neutral to be fixed.

Test results may be adversely affected by supply voltage fluctuations or electrical 'noise' during measurement. It is recommended that tests are repeated and the results verified, if measurement results are considered abnormal.

The *CM500* will measure the loop resistance from the supply end of the standard test leads, allowing for their resistance.

Operation (Contd).

Automatic testing

To aid rapid testing, the *CM500* can be set to start a test automatically when connected to the supply. This may be of use, for example, when using a clip and a probe. Select the range required and press the test key without the supply present. The instrument will display <100 V for approximately 30 seconds. Apply the supply voltage within this time and the instrument will pause before performing one test automatically.

Phase to Neutral or Earth loop impedance measurement - Power plug method

1. Select **(Loop) L-PE** or **L-N** as required.
2. Insert the plug into an installation socket.
3. Supply voltage and polarity are displayed.
4. Press the **TEST** key.
5. Measured loop value is displayed.

On completion of this test, prospective fault current can be displayed by pressing the **DISPLAY** key.

If desired the test can be repeated by pressing **TEST** again.

Phase-Earth loop impedance measurement-Two wire method

If an installation socket is not available, use the the 2-wire lead set.

1. Select **(Loop) L-PE**.
2. Connect the red lead to phase and the black lead to earth. No connection to neutral is required.
3. Supply voltage is displayed. **Note:-** Though displayed, polarity indications are invalid with the two wire lead set

and should be ignored

4. Press the **TEST** key.
5. Measured loop value is displayed.

On completion of this test, prospective fault current can be displayed by pressing the **DISPLAY** key.

If desired the test can be repeated by pressing **TEST** again.

Bonded Metalwork Testing (1)

This test is performed using the two wire lead set.

1. Connect the black lead to the bonded metalwork.
2. Connect the red lead to phase.
3. Select **(Loop) L-PE**
4. Supply voltage is displayed.
5. Press the **TEST** key.
6. Measured resistance value is displayed.

Bonded Metalwork Testing (2)

This test can also be performed using the optional earth bond test lead, allowing connection to an installation socket.

1. Connect the black flying test lead to the bonded metalwork.
2. Insert the power plug test lead into a socket (receptacle).
3. Select **(Loop) L-PE**.
4. Supply voltage is displayed.
5. Press the **TEST** key.
6. Measured resistance value is displayed.

Prospective Short Circuit Current measurement (PSCC)

The **PSCC** of a circuit is the largest Prospective Fault Current (PFC). In a single phase system, this would be the larger of the earth loop PFC and the neutral loop PFC. In a multi-phase system phase-phase loops also need to be considered and these can be measured using the **(Loop) L-L** switch position.

When **CM500** measures the loop resistance, it also calculates the PFC. After any loop test, this may be displayed by pressing the **DISPLAY** key.

The PFC is calculated by using the sum:-

$$\frac{\text{Nominal supply voltage}}{\text{Loop resistance}}$$

The nominal supply voltage depends on the actual measured voltage and the configuration of the instrument. As supplied, the *CM500* is configured as follows:-

Actual measured Voltage	Nominal Voltage
150 V	110 V
>150 V and <300 V	230 V
>300 V	400 V

PFC measurement accuracy

An accurate PFC measurement requires an accurate measurement of the loop resistance. The difference of a few digits in the loop resistance measured will have a large effect on the PFC displayed.

Errors can be reduced by:-

- Using the 2 wire lead set with prods and making a firm connection to clean conductors.
- Making several tests and taking the average.
- Ensuring that potential sources of noise in the installation are isolated (switched off).
- Ensuring that the instrument is calibrated.

Earth Loop Resistance measurement at 15 mA

The **LOOP 2 k Ω 15 mA** range is a high resolution, low current resistance range. The 15 mA current enables the earth loop resistance to be measured without tripping all types of RCDs with a rated current of 30 mA or higher. Tests may be made via installation sockets with the plug terminated test lead, or at any other point using the 2-wire lead set. Connections are required to Line and Earth only.

15 mA - Phase to Neutral or Earth loop impedance measurement - Power plug method

1. Select **(Loop) 2k Ω 15mA**.
2. Insert the plug into an installation socket.
3. Supply voltage and polarity are displayed.
4. Press the **TEST** key. Test progress is displayed.
5. Measured loop value is displayed

If desired the test can be repeated by pressing **TEST** again.

15 mA - Phase-Earth loop impedance measurement -2-wire method

1. Select **(Loop) 2 k Ω 15 mA**.
2. Firmly connect the red lead to phase and the black lead to earth. No connection to neutral is required.

Operation (Contd.)

3. Supply voltage is displayed.

Note:- Though displayed, polarity indications are invalid with the 2-wire lead set and should be ignored

4. Press the **TEST** key. Test progress is displayed.

5. Measured loop value is displayed.

If desired the test can be repeated by pressing **TEST** again.

Method of measurement

The phase-earth, phase-neutral or phase-phase loop resistance can be measured. The instrument takes a current from the supply and measures the difference between the unloaded and loaded supply voltages. From this difference it is possible to measure the loop resistance. The test current will vary from 15 mA to 40 A, depending on supply voltage and the loop resistance value. The test duration will depend on the loop resistance value.

Possible sources of error

The reading depends on a measurement of the supply voltage and therefore noise or transients caused by other equipment during the test could cause an error in the reading. One way to check for these is to do two tests and look for any difference in value. The instrument will detect some sources of noise and warn the user, where other instruments may give an incorrect reading. Any leakage current as a consequence of other appliances connected to the supply under test may affect the reading. If the Phase - Earth loop is being measured, this leakage may be due to filter capacitors etc.

RCD Testing

The *CM500* can test the operation of a variety of types of Residual Current Devices (RCD), measure the phase to earth loop resistance, and the contact voltage of the installation. Using an earth test spike, the earth resistance and fault voltage may be measured. If **Setting A** is selected when using the plug terminated lead set, the polarity of the mains socket is immaterial. Line and Neutral will be swapped if necessary, and an indication given on the display. **Setting b** requires Line and Neutral to be fixed.

Pre-Test Configuration

Before performing an RCD test it is necessary to ensure that the *CM500* is correctly configured for the rated **current** and the specific **type of RCD** to be tested, and for the **type of test** to be performed.

RCD Current Rating

From information given on the RCD to be tested, select the RCD current rating on the rotary switch.

RCD VAR switch position

This position enables any RCD with a non standard rated current between 10 mA and 1000 mA to be tested. The test is performed at the selected current, taking the **5I** multiplier into consideration



1. Select (**RCD**) **VAR**.
2. Toggle the **DISPLAY** key to display the test current.
3. Press the (◇) **RCL** keys until the required test current is displayed. Hold a key down to auto-repeat.
4. Press the **DISPLAY** key. The **Supply Voltage**, **Test Type** and **RCD type** are shown. These may be set up as given in the following sections.

Ramp and **Auto sequence** tests are only available if the test current is set to 10 mA. The maximum possible test current (including **5I** multiplier) is 1000 mA (300 mA for d.c. sensitive RCDs). These limits are halved if the supply voltage is less than 200 V.

Setting precision:- 10 - 50 mA 1 mA steps
 50 - 500 mA 5 mA steps
 500 mA - 1000 mA 10 mA steps

RCD Type

Pressing the **TYPE** key displays the RCD type symbols. From information given on the RCD to be tested, select and set the type of RCD.

Symbol	Test
	General
	Selective (delayed)
	D.C. Sensitive

D.C. Sensitive relays

Some RCDs are electromechanical devices which can be saturated by the presence of d.c. Therefore if a d.c. fault occurs, or an a.c. fault occurs in the presence of quite a small direct current, the RCD may not trip. In this way the RCD is disabled and this becomes a potential hazard. Because of this, 'd.c. sensitive' RCDs are available.

Selective or Time delayed RCDs

In some cases it may be necessary to have an RCD protecting an individual circuit or group of circuits. If a fault occurs, the RCD

nearest to the fault should trip to clear it, maintaining supplies to the other circuits. Selective RCDs (normal symbol ) are used to discriminate faults occurring on separate circuits, and these have a minimum as well as a maximum trip time.

Type of test

Display	Type of Test	Description
$\frac{1}{2}I$	No Trip	Performs a no-trip test at half the rated current of the selected RCD. The test measures the earth loop resistance and contact voltage, or with a test spike, the earth resistance and fault voltage.
0°	Trip Test	Trip test at the rated current of the selected RCD. A $\frac{1}{2}I$ test is carried out before this, and the resistance and voltage are available after the test. The test is always started on a zero crossing when the instantaneous voltage is on the rise.
180°	Trip test	As above, but the test is always started on a zero crossing when the voltage is on the fall.
	Ramp test	Test current increases from half the rated current of the RCD. The result is the current at which the trip opens.
5I	Trip Test	Trip test at 5 X the rated current of the selected RCD. The choice of 0° or 180° gives greater accuracy of measurement. A $\frac{1}{2}I$ test is carried out before this, and the resistance and voltage are available after the test.

Pressing the **I** key displays the Type of Test symbols individually in sequence. Select the type of the test to be performed.

Operation (Contd.)

No Trip Tests

When an $\frac{1}{2}$ I (or No Trip) test is performed, the loop or earth resistance is measured, and in **Setting b** a two second **No Trip** test follows.

Loop or Earth resistance measurement

The loop resistance is measured at half the rated RCD current selected. Contact voltage is displayed which is the loop resistance multiplied by the rated RCD current. A high loop resistance will cause the *CM500* to display >90 V, and safely abort the test.

The earth resistance is measured if a lead is connected into socket **[S]** on the top of the instrument. Refer to '**Earth Resistance Measurement**' for correct positioning of the earth test spike. The earth test gives the resistance of the local spike, whereas the loop test will give the entire Line-Earth loop resistance value.

2 second 'No Trip' test (Setting b only)

A requirement of the IEE regulations is that half the rated operating current of the RCD is drawn for 2 seconds, and the RCD must not trip. Tripping of the RCD will indicate that it is over sensitive, or that excessive earth leakage current is being drawn in the system. The load put onto the circuit is resistive and therefore the test current is sinusoidal if the supply is sinusoidal.

No Trip testing

The test is the same for all RCD types. Select the **Rated Current**, the **RCD Type** and $\frac{1}{2}$ I. Connect to the installation and press the **TEST** key. If the settings are correct, and the RCD is in order, the RCD trip should not operate and the **Contact** or **Fault** voltage will be displayed. If the RCD trip does operate during the

test, the message $\square\square$ is displayed. This could be due to incorrect current

rating selection, excessive leakage current in the circuit, or a faulty RCD. If the problem is excessive leakage current, the source of the problem must be located and rectified before a trip test is performed, otherwise the result of the trip test will be invalid. Earth or loop resistance can be shown by pressing the **DISPLAY** key.

Trip Tests

The instrument will measure the trip time or trip current of common, selective (time delayed) and d.c. sensitive RCDs. The trip time is measured by timing the period from the application of a resistive load to when the supply fails.

Some RCDs are sensitive to the polarity of the supply, i.e. whether the test current is applied with the instantaneous rising or falling. Tests should therefore be performed with the polarity 0° and 180° and the maximum time taken.

D.C. sensitive RCDs are tested with a pulsed waveform. The rms current is $\sqrt{2}$ x the rated operating current of the RCD. As with the normal RCDs, these should be tested with 0° and 180° polarity.

As the No Trip test can affect the trip time of some selective RCDs, there is a 30 second delay before activation of the trip test. It is possible to override this delay by pressing the **TEST** button when the instrument is counting (1...2...3...).

Note:- Significant operating errors can occur if loads, particularly rotating machinery and capacitive loads are left connected during tests.

RCD rating	D.C. sensitive RMS currents
10mA	14,1 mA
30mA	42,4 mA
100mA	141 mA
300mA	424 mA [†]
500mA	Not available
1000mA	Not available

† For supply voltages above 200 V only.

Trip Testing (measuring the trip time)

1. Select the RCD rated current on the rotary switch.
2. Connect to the supply as detailed below.
3. Select the required test using the **I** key - 0° or 180° for the normal trip tests, or **5I** together with 0° or 180° for a **5I** test.
4. Select the **RCD** type using the **TYPE** key.
5. Press the **TEST** button.

If the RCD trips, the first display depends upon the Setting selected. **Setting A:** The contact or fault voltage is displayed with the Loop or earth resistance and trip time available by pressing the **DISPLAY** key. **Setting b:** The trip time is displayed with the contact/fault voltage and Loop/earth resistance available by pressing the **DISPLAY** key.

150 mA 40 ms test

When an RCD is fitted for personal protection, a test current of 150 mA must cause the RCD to trip in less than 40 ms.

1. Select the 150 mA 40 ms rotary switch.
2. Connect to the supply as detailed below.
3. Select and set the Trip Test to 0° or 180° using the **I** key.
4. Press the **TEST** key.

If the RCD trips within 40 ms, the trip time is displayed.

Ramp Test (measuring the trip current)

The trip current is measured by applying a test current of half the rated trip current and increasing this every 200 ms. When the supply is cut, the current flowing is recorded and displayed.

A low trip current could be due to an overly sensitive RCD, or to leakage currents in the supply.

RCD rating	Current Range	Step Value
10mA	5..15mA	1 mA
30mA	15..50mA	1 mA
100mA	50..150mA	2 mA
300mA	150..300mA	6 mA
500mA	250..500mA	10 mA
1000mA	500..1040mA	52 mA

To determine the trip current of an RCD.

1. Select an appropriate RCD rated current on the rotary switch.

Operation (Contd.)

2. Connect to the supply as detailed on the next page.
3. Select the Ramp test  using the **I** key.
4. Select the RCD type using the **TYPE** key.
5. Press and hold the **TEST** button.

If the RCD trips, the first displayed result depends upon the Setting selected.

Setting A: The contact or fault voltage is displayed with the Loop or earth resistance, trip current and trip resistance available by pressing the **DISPLAY** key.

Setting b: The trip current is displayed with the trip resistance, contact/fault voltage and loop/earth resistance available by pressing the **DISPLAY** key.

The Trip current and the Trip resistance values are displayed with both the 0° and the 180° symbols. The Trip resistance is the fault required to trip the RCD.

Auto Sequence RCD Test

If the RCD is not located near a convenient installation socket, it could mean walking back and forward between the RCD and the instrument to reset the RCD each time it trips out. To simplify and speed up sequence testing, *CM500* can be set to automatically perform each subsequent test in the sequence each time that the power is restored. This test depends upon whether **Setting A** or **Setting b** is selected. The **Overcurrent** or **Fast Trip** is 150 mA if **Setting b** is selected, and **5I** if **Setting A** is selected. The display shows **150 mA** or **5I** symbols as appropriate. The test procedure is as follows:-

1. Connect to the supply as detailed on the next page.

2. Select the RCD rated current on the rotary switch.
3. Select Auto RCD test sequence by pressing the **I** key until the **½I**; **0°**; **180°** and **Fast trip** symbols are all displayed together. Auto test is only applicable to a.c. sensitive non delayed RCDs, therefore **Type** segments are not displayed.
4. Press and release the **TEST** button.
5. Reset the RCD within 30 seconds after each trip test.
6. Tests will be carried out in the sequence **½I**, **0°**, **180°**, **Fast Trip 0°** and **180°**. After each trip test, *CM500* will wait for up to 30 seconds for the supply to be switched back on before continuing with the next test. The test sequence will abort if any of the tests fail, or if the RCD is not reset within the time limit.

On completion, the result of the last Fast trip test is displayed. Press the **DISPLAY** key to sequentially display:-

- Supply voltage
- Supply Frequency
- Contact/Fault voltage
- Earth Loop/Earth Resistance
- 0° trip test time
- 180° trip test time
- 0° Fast trip test time
- 180° Fast trip test time

All results can be stored under a single circuit reference. See '**Test Result Storage, Deletion and Retrieval**'.

Connecting to the Supply

Power plug method

The simplest way of connecting to the installation is by inserting the power plug into a convenient installation socket. If **Setting A** is selected when using the plug terminated lead set, the polarity of the mains socket is immaterial. Line and Neutral will be swapped if necessary, and an indication given on the display. **Setting b** requires Line and Neutral to be fixed.

1. Insert the power plug into an installation socket.
2. Select and set the rated current, RCD type and the test type.
3. Supply voltage, configuration symbols and polarity are displayed.
4. Press the **TEST** key.
5. See previous notes for **Type of test**.

If desired the test can be repeated by pressing **TEST** again.

2-wire lead set method

If an installation socket is not available use the 2-wire lead set.

1. Connect the red lead to phase and the black lead to earth. No connection to neutral is made.
2. Select and set the **rated current, RCD type** and the **test type**.
3. Supply voltage and polarity are displayed prior to the test.

Note: Though displayed, polarity indication with the 2-wire lead set is invalid and should be ignored.

4. Press the **TEST** key.

5. See previous notes for **Type of test**.

If desired the test can be repeated by pressing **TEST** key again.

Automatic testing

To aid rapid testing, the *CM500* can be set to start a test automatically when connected to the supply. This may be of use, for example, when using a clip and a probe. Select the range required and press the test key without the supply present. The instrument will display **<100 V** for approximately 30 seconds. Apply the supply voltage within this time and the instrument will pause before performing one test automatically.

Operation (Contd.)

Earth Resistance Measurement

The *CM500* can rapidly measure the earth electrode resistance and earth resistance (from 0.01 Ω to 3.00 k Ω) of a TT installation using the earth test spike and the plug terminated test lead, or at any other convenient point on the installation using the 2-wire lead set. If **Setting A** is selected when using the plug terminated lead set, the polarity of the mains socket is immaterial. Line and Neutral will be swapped if necessary, and an indication given on the display. **Setting b** requires Line and Neutral to be fixed.



CM500 is calibrated to give the resistance from the supply ends of the test leads. Test results may be adversely affected by supply voltage fluctuations or electrical 'noise' during measurement. It is recommended that tests are repeated and the results verified, when measurement results are considered abnormal. Connect the test lead to the instrument first **and then** to the earth spike.

Inserting the Earth Test spike

A test spike must be inserted into the ground well away (>20 m) from the main earth electrode(s) or anything connected to the earth electrode(s). Buried earthed metal pipes, fences, etc. near to the spike could give a misleading low reading. The *CM500* may display 'E32' or a very low resistance if the spike is incorrectly positioned. To check the result, reposition the spike and verify the readings. Suitable test spikes and leads are contained in the accessory Earth Test Kit.

Earth resistance measurement - Power plug method

The earth resistance of an installation will include the effects of any parallel resistance paths from the **PE** conductor to earth e.g. cross bonded metal service pipes.

1. Insert the test spike.
2. Connect the 20 m earth test lead to the *CM500* [4 mm socket (**S**)] first and then to the test spike.
3. Select **Re**.
4. Insert the power plug into an installation socket.
5. Supply voltage and polarity are displayed.
6. Press the **TEST** key.
7. Measured earth resistance value is displayed.

Earth resistance measurement - 2- wire lead set method

1. Insert the Test spike.
2. Connect the 20 m earth test lead to the *CM500* [4 mm socket (**S**)] first and then to the test spike.
3. Select **Re**.
4. Connect the red lead to phase and the black lead to earth. No connection to neutral is necessary.
5. Supply voltage is displayed. **Note:-** Though displayed, polarity indications are invalid when using the 2-wire test lead set, and should be ignored.
6. Press the **TEST** key
7. Measured earth resistance value is displayed.

Earth Electrode Resistance Measurement

To measure the earth electrode resistance, the earth electrode must be disconnected from the **PE** conductor of the installation under test. To do this safely, the installation must be switched Off and isolated from the supply.

1. Insert the test spike.
2. Connect the 20 m earth test lead to the *CM500* [4 mm socket (**S**)] first and then to the test spike.

3. Switch Off and isolate the installation under test.
4. Disconnect the earth electrode.
5. Using the 2-wire lead set, connect the black lead to the earth electrode under test.
6. Select **Re**.
7. Carefully connect the red lead to the phase conductor of the incoming mains supply on the distribution board.
8. Supply voltage and polarity are displayed.
9. Press the **TEST** button.
10. Measured earth resistance value is displayed.

Note:- Though displayed, polarity indications are invalid using the 2-wire test lead set, and should be ignored.

11. Disconnect the red and black leads. Switch off the *CM500*.
12. Firmly re-connect the earth electrode.
13. Carry out a continuity test between the **PE** conductor and the earth electrode and confirm that a valid connection has been made.
14. Switch on the supply.
15. Carry out a loop resistance test.

Method of measurement

The earth resistance is measured by taking a current from the supply and injecting it into the resistance to be measured. The voltage change across the earth resistance is measured by the use of a remote probe 20-30 m away from any earth electrodes.

The test current will vary from 15 mA to 25 A, depending on supply voltage and the loop resistance value. The test duration will depend on the loop resistance value.

Possible sources of error

As with the loop resistance measurements, the reading depends on a measurement of the supply voltage and therefore noise or transients caused by other equipment during the test could cause an error in the reading. One way to check for these is to do two tests and look for any difference in value. The instrument will detect some sources of noise and warn the user where some instruments may have given an incorrect reading.

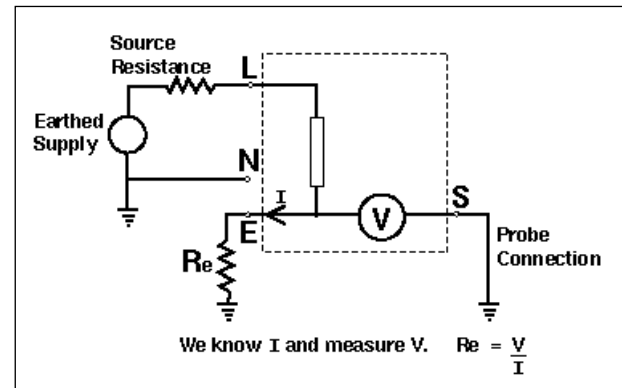

The measurement depends on the position of the probe. The probe must be positioned away from any part of the installation under test, so that it provides a valid reference earth. For a single earth electrode, the distance of 20 m is found to be sufficient. Be careful of secondary earth paths, such as service pipes. The best way to confirm the measurement is to try two probe positions.

Condition and Warning Indication

Condition	Display	Cause	Action
System Error		Hardware or software fault.	Switch 'Off', then 'On' and attempt re-test.
Low Battery		Battery voltage too low.	Replace battery
Touch Pad >100 V		Earth voltage too high.	Check installation or wiring to <i>CM500</i>
Supply voltage and Freq. out of range.	> or < and limit value	Supply voltage or freq. too high or low for test.	—
Thermal Trip Operated.		Too rapid testing with no pauses for heat dissipation	Pause between tests to allow cooling.
Supply interrupted during test.		RCD Tripped. or Supply Failure	Confirm RCD rating and check for excess earth leakage current
Noise.		Excessive external supply noise during earth loop or RCD test.	Identify and rectify, or wait and re-test.
Auxiliary spike R. too high.	>50kΩ and	Incorrect connection.	Rectify or re-position auxiliary spike
Earth test Spike Voltage too high.	>20V and	Standing V. on probe too high prior to test.	Rectify or re-position auxiliary spike
Auxiliary Spike		Spike connected.	As required
Fuse Ruptured.		No external d.c. V. and I during insulation test.	Replace fuse. (see page 7)
Memory full		Results memory full.	Download results and clear memory
Memory Corrupted		Results memory unintelligible	Press Test to attempt recovery

Error Numbers

Any hardware or software faults and errors will cause the display to show an error number in the form of a digital 'E' together with an identifying 2 digit number.

If such an error number is displayed, switch the instrument 'Off' and back 'On' again. Then repeat the test that was originally being carried out, or as given in the following table.

If the error number is again displayed, switch the instrument to 'Off', and return the instrument to the manufacturer for service, together with a description of the events leading to the message display. See '**Returning an instrument for Repair**' on page 39.

Error Number

Appropriate Action

E22
E23
E24

EEPROM failure. Stored data is lost. Attempt to delete the stored test results and then store another result. If Error Number persists, return the instrument for service.

E32

(**Loop LE, LN or LL**) Secondary internal thermal cut-out is open circuit. Return the instrument for service.

(**Re**) May be due to incorrectly positioned spike.

E33
E34
E37

(**Earth, Loop, or RCD**) Possibly due to excessive 'noise' on the supply, or the RCD unexpectedly trips together with an internal fault. If Error number persists, return the instrument for service.

Test Result Storage, Deletion and Retrieval

Saving Results

After a test, the result is displayed on the screen and this may be saved with additional information. A circuit number (1 - 99) may be assigned, and when moving site or building, circuits may be grouped using the distribution board feature. In this way, when downloading to *AVO PowerSuite*, the results can be easily split into different test schedules. When the results are displayed or printed, a change in the distribution board is indicated.

Changing Distribution Boards (DB)

Before a test the distribution board number may be changed as follows:-

1. Move the rotary selector switch to the **RCL** position. The code **rcl** is displayed.
2. Press the **SAVE** key. The currently selected DB code is displayed, e.g. **d01**.
3. This number may be changed using the \diamond **RCL** keys to display the required number.
4. The number can be accepted by pressing the **SAVE** key, or the procedure aborted by pressing the **EXIT** key,.
5. When the number is saved the code **Std** is displayed (accompanied by a long beep) to confirm that the data has been saved.

Testing may now continue with all subsequent results associated with the new distribution board number.

Saving a result

On completion and display of the measurement:-

1. Press and hold the **SAVE** key. After about 1 second, a

bleep will be heard. For a **Continuity, (M Ω) L-N** or **(Loop) L-N** test, a code, as given in the following table is displayed. This code is used to describe the circuit tested and can accordingly be modified by the user. For all other tests, a circuit number code is displayed, and you should proceed directly to step 4.

Test to be saved	Display code	Meaning
Continuity	r 1	Single circuit
	r 2	Single circuit
	r n	Single circuit
	r 1 2	R1 + R2 Return circuit
Insulation	n_E	N - PE
	L_n	L - N
	L_L	L - L
Loop	L_E	L - PE
	L_n	L - N
	L_E	L - PE
	L_L	L - L

2. The code may be changed by pressing the \diamond **RCL** keys.
3. The code may be accepted by pressing the **SAVE** key, or aborted by pressing the **EXIT** key.

Test Result Storage, Deletion and Retrieval (Contd.)

- The circuit number is displayed as 2 digits e.g. **c01**.
Note:- Many different tests may be saved under the same circuit number.
- The circuit number may be changed by pressing the \diamond **RCL** keys to display an appropriate number. Hold the key down to step through the circuit numbers.
- The number can be accepted and the results saved by pressing the **SAVE** key, or the procedure aborted by pressing the **EXIT** key.
- When the result is saved, the code **Std** is displayed (accompanied by a long bleep) to confirm that the data has been saved. The display of **FULL** indicates that there is no more test storage.

Delete all data

- Move the rotary selector switch to the **RCL** position. The code **rcl** is displayed.
- Press the \diamond **RCL** keys together. The code **dEL** is displayed.
- Confirm that the data is no longer required by pressing the **SAVE** key or abort by pressing any other key. The code **rcl** is displayed.

Clear data and re-set factory default settings

The *CM500* will remember certain values such as the insulation test voltage, the RCD test current and the lead null resistance, even if the instrument is switched Off and the battery removed.

These can be re-set to the factory default settings as follows:-

- Move the rotary selector switch to the **RCL** position. The

code **rcl** is displayed.

- Press the \diamond **RCL** keys together with the **Backlight** \odot key. The code **clr** is displayed.
- Confirm the operation by pressing the **SAVE** key, or abort by pressing any other key. The code **rcl** is displayed.

Print Results

- Connect printer and *CM500* using a serial printer lead.
- Move the rotary selector switch to the **RCL** position. The code **rcl** is displayed.
- Commence the printout by pressing the **TEST** key. Abort at any time by pressing and holding the **DISPLAY** key. The code **rcl** is displayed.

Note:- *CM500* can not respond to a busy signal given by a printer, and therefore waits at the end of each line. To change the wait time, see 'Initial Setup'.

Note:- The printout language can be changed. See 'Initial Setup'.

Retrieve Stored Results

It is possible to view previously stored test results by switching the rotary switch to the **RCL** position.

- Move the rotary selector switch to the **RCL** position. The code **rcl** is displayed.
- Select the required distribution board by pressing the **RCL** up or down keys. The distribution board numbers are shown in order that the the results were stored. Hold a key down to auto-repeat. A long bleep is sounded when the end

of the list is reached.

3. Press the **EXIT** key to return to the **RCL** display, or press the **DISPLAY** key to list the circuit numbers used in the currently displayed distribution board.
4. Select the required circuit number by pressing the **RCL** up or down keys. The circuit numbers are shown in numerical order. Hold a key down to auto-repeat. A long bleep is sounded when the end of the list is reached.
5. Press the **EXIT** key to return to the distribution board selection screen, or press the **DISPLAY** key to show the stored test codes. The following codes are used to identify test results:-

Code	Meaning
Con	Continuity Test
InS	Insulation Test
loop	Loop test
EAR	Earth Test
RCD	RCD test

6. Select the required test by pressing the **RCL** up or down keys. The tests are shown in the above order. Hold a key down to auto-repeat. A long bleep is sounded when the end of the list is reached.

7. Press the **EXIT** key to return to the circuit number selection screen, or press the **DISPLAY** key to scroll through the stored test results, together with any additional connection information.

Serial Cable Connections

To a PC for downloading data

Normally, a 9 way 'D' female socket to a 9 way 'D' female socket lead suitable for connecting PC to PC is required. This lead should not exceed 3 m in length. A lead is available as an accessory, or one can be made up as follows:-

Signal	CM500	PC	
		9 way 'D'	25 way 'D'
Rx	2	3	2
Tx	3	2	3
DTR*	4	6	
DSR	6	4	20
GND	5	5	7

* If making up a CM500 to PC 9 Way 'D' lead, it may be convenient to connect pin 4 to pin 6, enabling the lead to be used either way round.

To a Serial Printer for printing reports

Normally, a 9 way 'D' female socket to a 25 way 'D' female socket lead suitable for connecting PC to Printer is required. This lead should not exceed 3 m in length. A lead is available as an optional accessory, or one can be made up as follows:-

Signal	CM500	Printer 25 way 'D'
Tx	2	2
DSR	6	20
GND	5	7

The printer should be set to 9600 baud, 8 bits data, no parity and 1 stop bit.

The instrument uses an isolated serial interface and takes power from the PC or printer. This is fine for most desktop PCs and laptops but manufacturers are working to improve the battery life and the RS232 interface on some products has been re-designed for low power. Low voltage and high impedance outputs are possible.

The CM500 requires a modest 5,5 V at 6 mA, and most of this power is fed back into the PC or printer via the Tx (Transmit) line. This is expected at **DTR** (or RTS) and if this is not available, an additional supply of 5,5 - 20 V with a current capability of at least 6 mA is required. This should be connected between **GND** (pin 5) and pin 6 on the CM500, in place of any other connection to pin 6.

Specification

SUPPLY VOLTAGE MEASUREMENT

25 - 500 V Intrinsic accuracy $\pm 2\% \pm 2$ digits

SUPPLY FREQUENCY MEASUREMENT

d.c., 16 - 460 Hz Intrinsic accuracy $\pm 0,1\% \pm 1$ digit

INSULATION RANGES (to EN 61557-2)

Nominal Test Voltages 250 V, 500 V, 1 kV into 1 mA load

Displayed Range 1 k Ω to 499 M Ω at 1 kV

Intrinsic accuracy $\pm 2\% \pm 2$ digits

EN61557 Operating Range 0,10 M Ω to 99,9 M Ω

CONTINUITY RANGE (to EN 61557-4)

Displayed Range 0,01 Ω to 99,9 k Ω

Intrinsic accuracy $\pm 2\% \pm 2$ digits

Open Circuit Voltage 4 V - 5 V

Test Current (0 - 2 Ω) 200 mA - 250 mA

EN61557 Operating Range 0,10 Ω to 99,9 k Ω

LOOP AND EARTH ELECTRODE RESISTANCE MEASUREMENT (to EN 61557-3 and EN 61557-5)

LINE / EARTH & EARTH ELECTRODE

Displayed range 0,01 Ω to 3,00 k Ω

Nominal Supply 230 V, 50 Hz

Supply Voltage range 100 - 280 V, 45 - 65 Hz

EN61557 Operating Range 0,25 Ω to 3,00 k Ω

Intrinsic accuracy

0,01 Ω - 9,99 Ω	$\pm 4\% \pm 0,03\Omega$
10,0 Ω - 89,9 Ω	$\pm 5\% \pm 0,5\Omega$
90 Ω - 899 Ω	$\pm 5\% \pm 5\Omega$
900 Ω - 3,00 k Ω	$\pm 5\% \pm 20\Omega$

LINE - LINE (Phase/Phase) LOOP RESISTANCE MEASUREMENT (to EN 61557-3)

Displayed range 0,01 Ω to 19,99 Ω

Intrinsic accuracy $\pm 5\% \pm 0,03 \Omega$

Nominal Supply 230 V, 50 Hz

Supply Voltage range 100 - 480 V, 45 - 65 Hz

EN61557 Operating Range 0,25 Ω to 19,99 Ω

PROSPECTIVE FAULT CURRENT

Prospective fault current = $\frac{\text{Nominal voltage}}{\text{Loop resistance}}$

Measured Voltage	Nominal Voltage
> 150 V	110 V
150 V - 300 V	230 V
> 300 V	400 V

Prospective Fault Current is calculated from the respective loop

Specification (Contd.)

resistance. Ranges and accuracies are therefore derived from the previous section.

LINE EARTH LOOP RESISTANCE MEASUREMENT AT 15 mA (to EN 61557-2)

Displayed Range	0,1 Ω to 2,00 kΩ
Intrinsic accuracy	up to 200 Ω ± 3% ± 0,3 Ω over 200 Ω ± 5% ± 5 Ω
Noise Immunity	1σ of reading within 0,3 Ω on a normal domestic supply
Nominal Supply	230 V 50 Hz
Supply Voltage Range	100 - 280 V, 45 - 65 Hz
EN61557 Operating Range	5,0 Ω to 2,00 kΩ

RCD TESTING (to EN61557-6 up to 500 mA)

Selectable Ranges:	$I_{\Delta n}$, 30, 100, 300, 500, 1000 mA and variable from 10 to 1000 mA
Test Facilities:	Fault or contact voltage tests at $\frac{1}{2}I_{\Delta n}$ Loop and Earth resistance tests at $\frac{1}{2}I_{\Delta n}$ No Trip tests at $\frac{1}{2}I_{\Delta n}$ Trip tests at $I_{\Delta n}$, $5I_{\Delta n}$ Fast Trip test at 150 mA Ramp tests
RCD Types:	General purpose, delayed (Selective) and d.c. Sensitive

Nominal Supply:	230 V, 50 Hz
Supply range	100 - 280 V, 45 - 65 Hz

Note:- The maximum possible test current (including the 5I multiplier) is 1000 mA for d.c. sensitive RCDs). These limits are halved if the supply voltage is less than 200 V.

$\frac{1}{2}I_{\Delta n}$ TEST

FAULT OR CONTACT VOLTAGE

Displayed range	0 V to 90 V
Measurement range	5 V to 90 V

LOOP AND EARTH RESISTANCE (measured at $\frac{1}{2}I_{\Delta n}$)

$I_{\Delta n}$	DISPLAY RANGE	OPERATING RANGE (As in EN 61557)
10	0,01 kΩ to 9 kΩ	0,5 kΩ to 9 kΩ
30	1 Ω to 3 kΩ	170 Ω to 3 kΩ
100	1 Ω to 900 Ω	50Ω to 900 Ω
300	0,1 Ω to 300 Ω	17Ω to 300 Ω
500	0,1 Ω to 180 Ω	10Ω to 180 Ω
1000	0,1 Ω to 90 Ω	5Ω to 90 Ω

2 SECOND NO TRIP TEST at $\frac{1}{2}I_{\Delta n}$ (optional)

The test current flows for 2 seconds. A tripped RCD will result in a display of **< 1999 ms**

Intrinsic Test Current accuracy -8% / -2%

TRIP TESTS

$I_{\Delta n}$ Trip Test

This test will perform a short automatic $\frac{1}{2}I_{\Delta n}$ test, followed by a 30 second delay (Selective type only) then execute a Trip test.

General purpose Test $I_{\Delta n}$ test for up to 300 ms

Selective Test $I_{\Delta n}$ test for up to 2000 ms

Note:- The 30 second delay between the automatic $\frac{1}{2}I_{\Delta n}$ test and the $I_{\Delta n}$ test proper can be curtailed by operating the **TEST** key during the 30 second count period.

D.C. Sensitive Trip (For RCDs up to 300 mA)

This test is the same as the $I_{\Delta n}$ Trip Test above, but the test current is a half wave rectified a.c. with an r.m.s. value of $\sqrt{2}I_{\Delta n}$.

5 $I_{\Delta n}$ Trip Test (for RCDs up to 100 mA)

This test follows the same sequence of $\frac{1}{2}I_{\Delta n}$ test, 30 second delay (Selective type only) as the $I_{\Delta n}$ test. The same note applies.

General purpose test $5I_{\Delta n}$ test for up to 40 ms

Selective test $5I_{\Delta n}$ test for up to 150 ms

Timed Trip Tests

Trip time displayed Range 0,1 ms to test time limit

Intrinsic Trip time accuracy $\pm 1\% \pm 1$ ms

Intrinsic Test Current accuracy $+2\% / +8\%$

Ramp Test (Trip current measurement)

This test will perform an automatic $\frac{1}{2}I_{\Delta n}$ test followed by a 30 second delay (Selective type RCD only) and then execute an incremental ramp test.

Intrinsic Test Current accuracy $\pm 3\%$

$I_{\Delta n}$	RAMP RANGE	INCREMENT
10	5 - 15 mA	1 mA
30	15 - 50 mA	1 mA
100	50 - 150 mA	2 mA
300	150 - 300 mA	6 mA
500	250 - 500 mA	10 mA
1000	500 - 1020 mA	52 mA

150 mA 40 ms Trip Test

This is a stand alone test at 150 mA for 40 ms

Displayed Range 0,1 ms to 40 ms

There is no associated $\frac{1}{2}I_{\Delta n}$ test or Delay.

POWER SUPPLY

8 x 1,5 V Alkaline cells type LR6 or 1,5 V nickel cadmium rechargeable cells.

A new set of alkaline battery cells will typically give more than 4500 insulation or 3250 continuity tests. A mains supply is also required to carry out RCD, Loop and Earth tests.

FUSES

Replaceable 500mA (F) 500V HBC 10kA

Non replaceable 2 x 7A (SIBA 70-065-63)

The 500 mA fuse is accessible from the battery compartment and protects the Insulation and Continuity circuits. The 7 A fuses protect the instrument and are not replaceable by the user. Ruptured fuses are indicated by the display of the  symbol when a test is attempted.

Specification (Contd.)

SAFETY

Meets the requirements for double insulation to IEC1010-1 (1995) EN61010-1 (1995) Installation Category III***, up to 230 V to earth and 400 Volts phase to phase, without the need for separately fused test leads. If required, fused test leads are available as an optional accessory.

Complies with the relevant parts of EN 61557:1997-02 as detailed below.

*** Relates to the transient overvoltages likely to be met in fixed wiring installations.

E.M.C. Meets EN50081-1 and EN50082-1 (1992)

ENVIRONMENTAL PROTECTION

IP40 - The instrument is designed for indoor use, or outdoor use if suitably protected.

TEMPERATURE RANGE

Operating -5°C to +40°C up to 90% RH

Storage -25°C to +65°C up to 90% RH

GENERAL

Dimensions 245 mm x 200 mm x 95 mm

Weight 1,35 kg with battery

Cleaning Wipe the disconnected instrument with a clean cloth dampened with soapy water or Isopropyl Alcohol (IPA).

IEC 61557 / EN 61557

Complies with the following parts of EN 61557, Electrical safety in low voltage systems up to 1000 V a.c. and 1500 V d.c. - Equipment for testing, measuring or monitoring of protective measures:-

Part 1 - General requirements

Part 2 - Insulation resistance

Part 3 - Loop resistance

Part 4 - Resistance of earth connection and equipotential bonding (Continuity testing)

Part 5 - Resistance to earth

Part 6 - Residual current devices (RCDs)

Accessories

		Part Number
Test and carry case	Holds, and supports the instrument to allow 'hands free' operation in use, and protection when not in use.	6420-114
Pouch	Holds, and protects the instrument when not in use.	6420-121
Carrying strap	Attaches to case or instrument	6220-611
2-wire Test lead set	With prods and clips	6231- 631
3-wire test lead	For three phase sequence testing, including 2 prods and 3 clips.	6231-632
U.K. Mains plug test lead.	Fitted with BS1363 fused plug.	6231-633
Euro Mains plug test lead	Fitted with CEE7/7 plug.	6231-635
U.K. Earth bond test lead	Fitted with BS1363 fused plug.	6231-634
Switch Probe <i>SP2</i>	2-wire lead set with a ' Test ' key in the black probe	6231-636
2-wire test lead set (5m)	2 wire lead set with 5m long leads.	6231-637
Fused probe and clip set (2 probes and 3 clips)	Replace normal probes and clips supplied with 2 and 3 wire test test lead kits. 600 V max.10A fuse.	6180-405
Computer Serial lead	To connect the instrument to PC with 9 way 'D' connector, 1,8 m long.	25955-025
Printer serial lead	To connect the instrument to serial printer, with 25 way 'D' socket	25955-026
3½ inch diskette	Installation Tester Setup	6220-629
Earth test spike	For earth electrode measurements	5152-253
30 m of test lead on winder	For earth electrode measurements	6231-148
AVO® <i>PowerSuite</i> ™	Windows ™ program for Installation Testing certificate generation etc.	Contact Distributor

Accessories (Contd.)

Publications

Part Number

User Guide †

6172-258

'Testing Electrical Installations'

6172-129

A detailed account of how to carry out practical testing to BS 7671 (16th Edition IEE Wiring Regulations).

'A Stitch in Time'

AVTM21-P8B

The complete guide to electrical installation testing.

'Getting Down to Earth'

AVTB25-TA

A practical manual on earth resistance testing.

† Available in several languages. Please contact your local distributor for availability.

Basic and Service Error Calculation

Basic and service errors for Insulation and Resistance ranges

The basic error is the maximum inaccuracy of the instrument under ideal conditions, whereas the service error is the maximum inaccuracy taking into effect of battery voltage, temperature, interference, and system voltage and frequency, where applicable.

After determining the service error, we can then calculate the measurement range. This is the range of measurement over which the error in service is less than 30% of the reading. Digital instruments are affected by the number of digits error - for example a value 0,10Ω measured with the continuity range may give a display in the range 0,07 Ω to 0,13 Ω which is a maximum error of 30%. Therefore the measurement range measuring low resistance is 0,10 Ω to 99,9 Ω. When checking that a measurement does not exceed a limit, the service error needs to be taken into account and these tables enables this to be done quickly and easily. These will guarantee that the value being measured is greater than or less than the limit value specified as appropriate.

Limit	Min. Indicated reading	Limit	Min. Indicated reading
0,10	0,14	4,50	4,72
0,15	0,20	5,00	5,24
0,20	0,25	6,00	6,28
0,25	0,30	7,00	7,32
0,30	0,35	8,00	8,36
0,35	0,40	9,00	9,40
0,40	0,46	10,0	10,8
0,45	0,51	15,0	16,0
0,50	0,56	20,0	21,2
0,60	0,66	25,0	26,4
0,70	0,77	30,0	31,6
0,80	0,87	35,0	36,8
0,90	0,98	40,0	42,0
1,00	1,08	45,0	47,2
1,50	1,60	50,0	52,4
2,00	2,12	60,0	62,8
2,50	2,64	70,0	73,2
3,00	3,16	80,0	83,6
3,50	3,68	90,0	94,0
4,00	4,20		

Insulation Resistance - MΩ

Limit	Max. Indicated reading	Limit	Max. Indicated reading	Limit	Max. Indicated reading	Limit	Max. Indicated reading
0,10	0,06	4,50	4,28	150	140	5,00 k	5,76 k
0,15	0,10	5,00	4,76	200	188	6,00 k	5,72 k
0,20	0,15	6,00	5,72	250	236	7,00 k	6,68 k
0,25	0,20	7,00	6,68	300	284	8,00 k	7,64 k
0,30	0,25	8,00	7,64	350	332	9,00 k	8,60 k
0,35	0,30	9,00	8,60	400	380		
0,40	0,34	10,0	9,56	450	428		
0,45	0,39	15,0	14,0	500	476		
0,50	0,44	20,0	18,8	600	572		
0,60	0,54	25,0	23,6	700	668		
0,70	0,63	30,0	28,4	800	764		
0,80	0,73	35,0	33,2	900	860		
0,90	0,82	40,0	38,0	1,00 k	900		
1,00	0,92	45,0	47,8	1,50 k	1,40 k		
1,50	1,40	50,0	47,6	2,00 k	1,88 k		
2,00	1,88	60,0	57,2	2,50 k	2,36 k		
2,50	2,36	70,0	66,8	3,00 k	2,84k		
3,00	2,84	80,0	76,4	3,50 k	3,32 k		
3,50	3,32	90,0	86,0	4,00 k	3,80 k		
4,00	3,80	100	92,0	4,50 k	4,28 k		

Continuity / Low Resistance Ω

Error = 4%+4d

Basic and Service Error Calculation (Contd.)

Limit	Max. Indicated reading	Limit	Max. Indicated reading	Limit	Max. Indicated reading	Limit	Max. Indicated reading
0,10	0,03	1,50	1,29	20,0	17,0	300	260
0,15	0,08	2,00	1,74	25,0	21,5	350	305
0,20	0,12	2,50	2,19	30,0	26,0	400	350
0,25	0,17	3,00	2,64	35,0	30,5	450	395
0,30	0,21	3,50	3,09	40,0	35,0	500	440
0,35	0,26	4,00	3,54	50,0	44,0	600	530
0,40	0,30	4,50	3,99	60,0	53,0	700	620
0,45	0,35	5,00	4,44	70,0	62,0	800	710
0,50	0,39	6,00	5,34	80,0	71,0	900	800
0,60	0,48	7,00	6,24	60,0	80,0	1,00	0,86
0,70	0,57	8,00	7,14	100	89,0	1,50	1,31
0,80	0,66	9,00	8,04	150	125	2,00	1,76
0,90	0,75	10,0	8,94	200	170	2,50	2,21
1,00	0,84	15,0	12,5	250	215	3,00	2,66

Loop Resistance and Earth Electrode Resistance

Limit	Max. Indicated reading	Limit	Max. Indicated reading
3,0	1,2	70,0	64,2
3,5	1,7	80,0	73,6
4,0	2,2	90,0	83,0
4,5	2,6	100	92,4
5,0	3,1	150	139
6,0	4,0	200	183
7,0	5,0	250	230
8,0	5,9	300	277
9,0	6,9	350	324
10,0	7,8	400	371
15,0	12,5	450	418
20,0	17,2	500	465
25,0	21,9	600	559
30,0	26,6	700	653
35,0	31,3	800	747
40,0	36,0	900	841
45,0	40,7	1,00 k	935
50,0	45,4	1,50 k	1,41 k
60,0	54,8	2,00 k	2,00 k

Error = 4%+4d

Loop Resistance 2 kΩ 50 mA

Use these tables to determine the minimum indicated reading for a limit, taking into account the maximum service error of the instrument.

Repair and Warranty

The instrument circuit contains static sensitive devices, and care must be taken in handling the printed circuit board. If the protection of an instrument has been impaired it should not be used, and be sent for repair by suitably trained and qualified personnel. The protection is likely to be impaired if, for example, the instrument shows visible damage, fails to perform the intended measurements, has been subjected to prolonged storage under unfavourable conditions, or has been exposed to severe transport stresses.

New Instruments are Guaranteed for 1 Year from the Date of Purchase by the User.

Note: Any unauthorised prior repair or adjustment will automatically invalidate the Warranty.

Instrument Repair and Spare Parts

For service requirements for *MEGGER®* Instruments contact:-

AVO INTERNATIONAL	or	AVO INTERNATIONAL
Archcliffe Road		510 Township Line Road
Dover		Blue Bell
Kent, CT17 9EN.		PA 19422-2795
England.		U.S.A.
Tel: +44 (0) 1304 502243		Tel: +1 (215) 646-9200
Fax: +44 (0) 1304 207342		Fax: +1 (215) 643-7215

or an approved repair company.

Approved Repair Companies

A number of independent instrument repair companies have been approved for repair work on most *MEGGER®* instruments, using genuine *MEGGER®* spare parts. Consult the Appointed Distributor / Agent regarding spare parts, repair facilities and advice on the best course of action to take.

Returning an Instrument for Repair

If returning an instrument to the manufacturer for repair, it should be sent freight pre-paid to the appropriate address. A copy of the Invoice and of the packing note should be sent simultaneously by airmail to expedite clearance through Customs. A repair estimate showing freight return and other charges will be submitted to the sender, if required, before work on the instrument commences.



AVO INTERNATIONAL

Archcliffe Road
Dover
Kent, CT17 9EN.
England.

Tel: +44 (0) 1304 502100
Fax: +44 (0) 1304 207342

510 Township Line Road
Blue Bell
PA 19422-2795
U.S.A.

Tel: +1 (215) 646-9200
Fax: +1 (215) 643-2670

4651 S. Westmoreland Road
Dallas
TX 75237-1017
U.S.A.

Tel: +1 (800) 723-2861 (U.S.A. only)
Tel: +1 (214) 330-3203 (International)
Fax: +1 (214) 337-3038

MEGGER SA
29 Allée de Villemomble
93340 Le Raincy
Paris, France

Tel: +33 (1) 43.02.37.54
Fax: +33 (1) 43.02.16.24

This instrument is manufactured in the United Kingdom. The Company reserves the right to change the specification or design without prior notice.

MEGGER and *AVO* are registered Trade Marks of **AVO INTERNATIONAL LIMITED**. Copyright© **AVO INTERNATIONAL LIMITED**.