

Megger[®]

MIT300 Series Insulation and Continuity Testers

USER MANUAL

 **SAFETY WARNINGS**

- **Safety Warnings** and **Precautions must be read** and understood before the instrument is used. They **must** be observed during use.
- The circuit under test must be switched off, de-energised and isolated **before** test connections are made when carrying out insulation and continuity tests.
- Circuit connections and exposed metalwork of an installation or equipment under test **must not** be touched.
- The live circuit warning and automatic discharge are additional safety features which may fail and therefore **safe working practices must be observed**.
- The voltage function will only work if the instrument is functional and switched on.
- After insulation tests, capacitive circuits must be allowed to discharge **before** disconnecting test leads.
- The instrument **should not** be used if any part of it is damaged.
- Test leads, probes and crocodile clips must be in good order, clean and with no broken or cracked insulation.
- Ensure that hands remain behind guards of probes/clips when testing.
- National Safety Authorities may recommend the use of fused test leads when measuring voltage on high-energy systems.
- Replacement fuses **must** be of the correct type and rating. Failure to fit the correctly rated fuse may result in a safety hazard and may cause damage to the instrument in the event of an overload.
- The battery cover **must** be in place whilst conducting tests.
- The MIT310A is designed for use only in a controlled electromagnetic environment.

NOTE**THE INSTRUMENT MUST ONLY BE USED BY SUITABLY TRAINED AND COMPETENT PERSONS.**

Users of this equipment and/or their employers are reminded that National Health and Safety Legislation requires them to carry out valid risk assessments of all electrical work so as to identify potential sources of electrical danger and risk of electrical injury such as inadvertent short circuits. Where the assessments show that the risk is significant then the use of fused test leads may be appropriate.

CONTENTS

Safety warnings	4	Insulation testing	15
Introduction	2	Test lock	15
General description	4	SP4F Switched (optional accessory for MIT320)	16
Case contents	5	Test result storage (MIT330 only)	16
LCD display	6	Replacing batteries and fuses	18
Front panel (digital instruments)	6	Low battery warning symbol	18
Connection panel	7	To replace batteries	18
Lid open/closure	7	Fuse replacement (user replaceable)	19
Preparations for use (all instruments)	8	Preventive maintenance	19
Batteries	8	Technical specification	20
Preliminary test lead check	8	Accessories and equipment	23
General operating instructions	8	Repair and Warranty	24
General functions	8		
Test lead connection.	9		
Continuity measurement (MIT300, 310, 320, 330)	10		
Test lead null	10		
Continuity test (MIT300, 310,320, 330)	10		
Continuity Buzzer (MIT300, 310, 320, 300)	11		
Continuity buzzer mode:	11		
Setup mode (MIT320/330 only)	11		
Insulation testing - General	12		
Insulation test	12		
Test lock	13		
Insulation test (M Ω alarm ON/OFF (MIT320 only)	13		
M Ω threshold adjustment (MIT320/330 only)	13		
Insulation test lock disable (MIT320/330 only)	13		
AC / DC Voltage measurement	14		
Analogue Instrument MIT310A	14		
Test lead null	14		
Continuity test	15		
Continuity buzzer test	15		

Symbols used on the instrument are:



Caution: risk of electric shock



Caution: refer to accompanying notes



Equipment protected throughout by Double Insulation (Class II)



Equipment complies with current EU directives.



Equipment complies with 'C tick' requirements

INTRODUCTION

Thank you for purchasing the Megger Insulation Tester.

For your own safety and to get the maximum benefit from your instrument, please ensure that you read and understand the following safety warnings and instructions before attempting to use the instruments.

This user guide describes the operation and functions of the following:

MIT300 Series of insulation and continuity testers:

MIT300

MIT310

MIT310A

MIT320

MIT330

GENERAL DESCRIPTION

The MIT300 series variants have the following features:

	MIT300	MIT310	MIT310A	MIT320	MIT330
Insulation testing					
1 kV Insulation range		■	■	■	■
500 V Insulation range	■	■	■	■	■
250 V Insulation range	■	■	■	■	■
Insulation test full scale	999 M Ω	999 M Ω	999 M Ω	999 M Ω	999 M Ω
Insulation limit alarm 0.01 M Ω to 1 G Ω				■	■
Continuity					
Voltmeter range (600 V digit)		■	■	■	■
Continuity buzzer	■	■	■	■	■
Adjustable buzzer threshold 1 Ω to 20 Ω				■	■
Audible buzzer disable				■	■
Lead null to 9.0 Ω (0.5 Ω for MIT310A)	■	■	0.5 Ω	■	■
Stored test lead null	■	■	■	■	■
Resistance					
10 Ω to 1M Ω resistance range				■	■

CASE CONTENTS

	MIT300	MIT310	MIT310A	MIT320	MIT330
Features					
Locking test button	■	■	■	■	■
Backlight and rotary switch illuminations				■	■
Voltage warning	■				
Default voltmeter		■	■	■	■
Auto-power-down with defeat	■	■		■	■
Switched test probe connector				■	■
Switched test probe				■	■
Results storage					■
Downloading					■
USB					■

Please complete the warranty card and return it to Megger Limited as soon as possible to help us reduce any delays in supporting you, should the need arise.

Case contents

- 1 x MIT300 series insulation tester
- 1 x Red/Black test lead set with clips
- 8 x AA (LR6) batteries fitted
- 1 x Warranty card
- 1 x Certificate of test
- 1 x Calibration certificate
- 1 x CD containing user manual
- 1 x Printed quick start guide
- 1 x USB lead (MIT330 only)
- 1 x SP4F switched probe (MIT320 and MIT330 only)

LCD DISPLAY

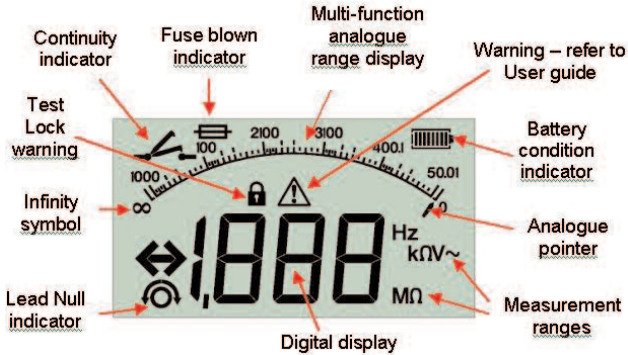

FRONT PANEL (DIGITAL INSTRUMENTS)

MIT300, 310, 320 and 330

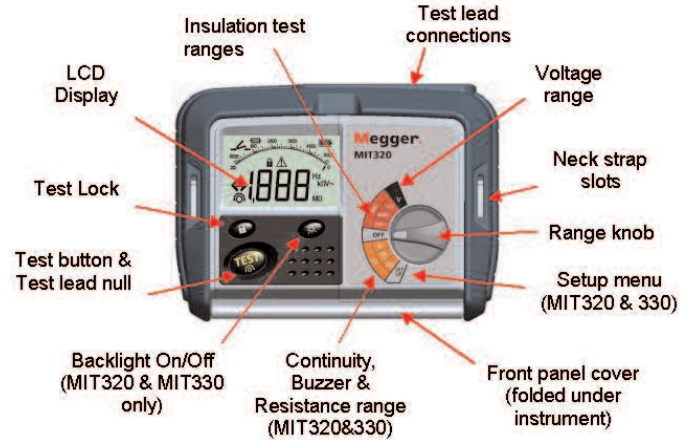

MIT310A

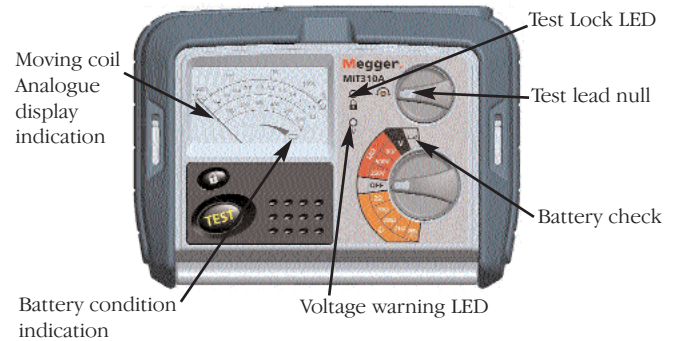

Connection Panel

MIT300 Series test lead connections

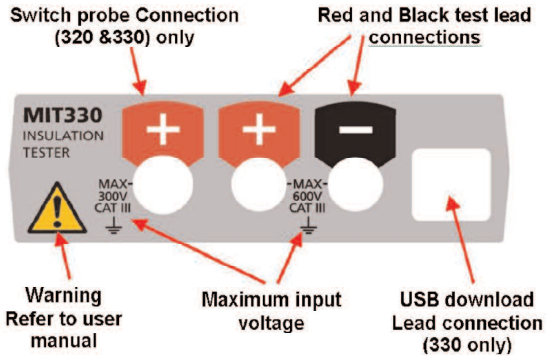

An interlock sliding panel prevents connection of unsafe test lead configurations. (MIT320/MIT330 only)

MIT330 Additional Controls

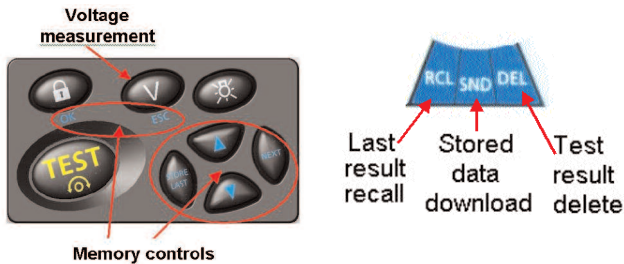

Memory control keys:

- STORE: Store initiates the storing of a test result.
- LAST/NEXT: Selects the type of location; ie Job, distribution board, circuit, phase etc.
- ESC: Aborts a save at any time.
- OK: Final operation to save the result.
- ▲ Selects the job, db, circuit number; ie 01,02,03 etc
- ▼

Lid open/closure

1. Open lid by lifting up front panel tab (1).
2. Fold-away underneath instrument (2 & 3) and push into retaining slot (4).

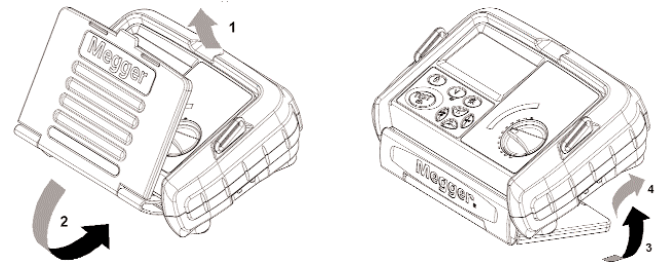

PREPARATIONS FOR USE (ALL INSTRUMENTS)

Batteries

The Megger MIT300 series of instruments are supplied with batteries fitted. When batteries become exhausted, refer to page 18, battery replacement.

Warning: **Do not** switch the instrument on with the battery cover removed.

Preliminary test lead check

Functional verification

1. Before each use of the instrument visually inspect the test leads, prods and crocodile clips to confirm that their condition is good, with no damaged or broken insulation.
2. Check continuity of the test leads by firmly shorting the leads together and read the test lead resistance measurement directly from the display, which should be less than 1.0 Ω .

Refer to page 10 for operation guide.

3. Supply voltage

Using an approved method, ensure the circuit to be tested has been fully disconnected from the supply prior to using the instrument.

GENERAL OPERATING INSTRUCTIONS

Safety note:

If a voltage greater than 25 V appears on the circuit under test the instrument will default to a voltage measurement and display the supply voltage.

On supply voltages over 50 V the instrument will prevent the test button from performing an insulation test, protecting your instrument from damage.

General functions

Voltage Testing on High Energy Systems

Use extreme care when using or measuring voltages above 30 V, particularly in high energy systems. Fused test leads are available as optional accessories for local situations where increased protection is required. See accessories section.

Tests lock

The LOCK  indicates when an INSULATION test range is locked ON.

It is activated by holding down the [TEST] button, and pressing the LOCK  button.

Note: See analogue section for MIT310A

Warning: Hazardous voltages can exist on the insulation test range all the time the [TEST] button is locked down.

Voltage warning (MIT300 only)

If a voltage exists on the circuit under test, the instrument will emit a warning beep.

If a voltage greater than 50 V exists, testing will be automatically inhibited.

Voltage warning (MIT310A only)

If a voltage exists on the circuit under test the voltmeter will indicate this. However voltages under 50 V will be displayed but may be difficult to read from the analogue display.

Default voltmeter (MIT310, MIT320 and MIT330)

The default voltmeter automatically operates if a voltage is present across the test probes of greater than 25 V.

In Volts range the meter operates at greater than 2 V.

If the voltage exceeds 50 V any further testing is inhibited for safety. The voltage will be displayed.

Backlight operation (MIT320 and MIT330 only)

Both the display and test ranges are backlit. The backlight function can be selected at any time while the instrument is switched on by pressing the BACKLIGHT  button.

The backlight function will switch off automatically 20 seconds after the instrument has finished testing.

Display warning symbols



Refer to user manual

Any time the warning triangle is displayed the operator should refer to the user manual for further information.



Range lock

Displayed at any time the [TEST] button is locked in the on position.



Lead nulled

Indicates that the test lead resistance has been removed from the test result.



Battery condition indication. Refer to page 18.



Fuse blown indicator, appears when an instrument fuse has failed. Refer to page 19.

Test lead connection

The Red/Black test lead set should be connected to the appropriate sockets on the rear of the instrument marked + and – respectively.

Test probes and crocodile clips are supplied for connection to the circuit under test.

Fused test leads are available as an optional accessory, please refer to accessories list at the end of this document.

Application

This instrument may be connected live to earth or between live conductors of systems that have a rated voltage of 600 V a.c. rms to earth and an installation (overvoltage) Category III or lower, or CATIV applications with a rated voltage of 300 V or less.

This means that the instrument may be connected to any fixed wiring of a building installation, but not to primary supply circuits such as overhead cables. To maintain user safety and ensure accurate measurements, only use the test leads supplied by Megger Limited.

CONTINUITY MEASUREMENT (MIT300, 310, 320, 330)

All continuity measurements are AUTO ranging from 0.00 Ω to 100 Ω on Digital/analogue scale).

The MIT310A has manual range selection to 2 k Ω .

From 0.00 Ω to 10 Ω test current is greater than 200 mA. From 10 Ω to 100 Ω test current is greater than 20 mA. (See page 15 for MIT310A)

Test lead Null

(See page 14 for MIT310A)

Before using the continuity range or buzzer range for the first time, the test lead resistance should be 'zeroed out'. This ensures any measurement does not include the resistance of the test leads.

1. Connect the test leads to the instrument and firmly short both leads together.
2. Wait for the reading to stabilise and press the [TEST] button.
3. Display of the  confirms test leads zeroing. The display should be 0.00 Ω .

Note: Lead zeroing is retained when the instrument is switched off, or auto shut-off operates.

To remove the 'lead zero' press the [TEST] button again.

Continuity test (MIT300, 310,320 and 330)

(See page 15 for MIT310A)

To make a continuity measurement:

1. Turn the instrument 'On' by selecting the continuity Ω range.
2. If required, zero test lead resistance, see test lead null (above).
3. Connect the test probes to the isolated circuit under test. The test will start automatically.

4. The display shows the resistance value. (Maximum 99,9 Ω)

5. Disconnect the test probes to terminate the test.

6. On completion of testing switch to the [OFF] position. Alternatively auto shut off operates after a period of instrument inactivity.

CONTINUITY BUZZER (MIT300, 310, 320, 330)



(See page 15 for MIT310A)

Continuity buzzer mode:

The continuity buzzer has a fast check which looks for a resistance greater than 1.0 M Ω and will buzz when found. If a voltage is detected the continuity test will stop (the instrument will not be damaged).

The continuity buzzer will then check for a low resistance path less than 5 \approx (or as set on the MIT320 and MIT330), and continue to buzz.

To perform a continuity buzzer test:

1. Set the test range knob to the continuity buzzer  position
2. Connect the test probes to the isolated circuit under test.
3. A continuous beep note sounds when the test leads make contact with resistance less than 5 Ω and contact is maintained. (Resistance greater than 5 Ω is indicated by a short or intermittent beeping).
4. The buzzer visual indicator symbol  closes when continuity is detected.

Setup mode (MIT320 and MIT330 only)

Continuity buzzer threshold adjustable

The adjustable buzzer threshold adjustment allows the operator to set the maximum resistance at which the buzzer operates.

To adjust:

1. Switch the MIT320/MIT330 to [SETUP]. The display should flash between CON and 5.00 Ω .
2. Press and hold down the [TEST] button
3. The buzzer threshold resistance is displayed. This will count down from 5 Ω to 1.0 Ω .

4. When the display reaches the desired value release the [TEST] button
5. Press the  button to store the value

To select a threshold value above 5.0 Ω

1. Switch the MIT320 or MIT330 to [SETUP]. The display should flash between CON and 5.00 Ω .
2. Hold the [TEST] button down until the display shows 1.0 Ω .
3. Release the [TEST] button.
4. Press the [TEST] button again. It will commence counting down from 20 Ω .
5. Release the [TEST] button at the desired value.
6. Press the LOCK  button to store the value.

Buzzer ON/OFF (silent buzzer)

To disable the continuity buzzer:

1. Switch the MIT320 or MIT330 to [SETUP]. The display should flash between CON and 5.00 Ω .
2. Press and release the [TEST] button until the BUZ sign is displayed.
3. Press and hold the [TEST] button to select the OFF option (Press and hold again to select ON).
4. Press the Lock  to store the value.

INSULATION TESTING - GENERAL

(Refer to page 14 for additional MIT310A notes)

Safety note:

Insulation testing is performed at high DC voltages and could be hazardous if touched. Always observe the safety precautions when performing an Insulation test, and ensure all necessary health and safety precautions are observed.

Automatic Discharge: Capacitive circuits are automatically discharged when the test button is released following an insulation test.

Insulation measurements are performed at either 250 V, 500 V or 1000 V.

Insulation test

FIG.1

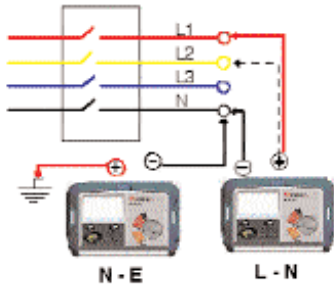

The insulation tests apply a known voltage to the circuit under test and measure the resulting leakage current.

The circuit under test must be completely de-energised and isolated before test connections are made.

To perform an insulation test:

1. Turn the instrument 'On' by selecting the desired 250 V, 500 V or 1000 V [MΩ] range.
2. Connect the test probes to the isolated circuit under test.
3. Press and hold the [TEST] button; allow the display to settle.
The reading will remain displayed for a few seconds after the push button is released.
4. Release the [TEST] button before removing the test leads (to enable the instrument to discharge the circuit under test). If the display shows VOLTS, wait.
5. On completion of testing switch to the 'OFF' position. Alternatively auto shut-off operates after a period of inactivity.

For MIT310A see notes on insulation testing page 15

Note: To prevent accidental application of 1 kV, a warning display will flash 1000 V prior to the start of the first 1000 V test.

Note: 50Hz noise from the circuit under test below 100 μ A or 25 V is ignored and will not affect test accuracy.

Higher levels of noise will cause the default voltmeter to indicate. Above 50 V (or 200 μ A) testing is inhibited.

Test lock

The insulation test can be locked on by pressing the lock  whilst holding down the [TEST] button.

To disable lock press the [TEST or LOCK] button.

Insulation test M Ω alarm ON/OFF (MIT320/MIT330 only)

The buzzer can be enabled or disabled for working in office environments.

To enable the buzzer:

1. Switch the instrument to [SETUP].
2. Repeatedly press the [TEST] button until the display shows ON/OFF.
3. Press and hold the [TEST] button to select ON.
4. Press the  button to save.

To disable the buzzer:

1. Switch the instrument to [SETUP].
2. Repeatedly press the [TEST] button until the display shows RON/ON.
3. Press and hold the [TEST] button to select OFF.
4. Press the  button to save.

M Ω threshold adjustment (MIT320 and MIT3300 only)

The buzzer threshold adjustment allows the operator to set the resistance above which the buzzer operates. The instrument will beep so long as the insulation value measured remains above the threshold value.

The instrument is supplied with the threshold level set to OFF and the threshold value set to 1.00 M Ω .

To adjust:



1. Switch the instrument to [SETUP]
2. Repeatedly press the [TEST] button until the display shows RES.
3. The initial insulation alarm level is set to 1.00 M Ω .
4. Press and hold down the [TEST] button. The Threshold limit will decrease from 999 M Ω to 1.0 M Ω .
5. When the display reaches the desired value release the [TEST] button.

6. Press the  button to store the value.

The instrument will now beep every time an insulation test is performed, and the measured value is greater than the threshold value set. (only if buzzer is enabled)

Insulation test lock disable (Not MIT310A)

The instrument is shipped with the test lock function enabled. To disable the test lock function:

1. Ensure the instrument is switched off.
2. Hold down the  button and turn the range knob to M Ω 500 V.
3. Keep the  button depressed for 10 seconds.
4. The instrument shall display OFF to indicate the lock function is disabled.

This setting is permanently stored.

To re-enable the test lock function, repeat the above process.

If a voltage greater than 2 V a.c. or d.c. is present at the terminals the measured voltage is indicated on the display. If the fuse is blown the voltmeter will still operate - see note 1.

For normal voltage measurement:

1. Set the range switch to [V]
2. Connect the test leads to the circuit under test.
3. The display will show the voltage across the test leads.

Note: measured voltage should not exceed 600 V phase to earth.

NOTE 1.

When fuse is blown:

MIT300 - MIT330 voltmeter will operate normally when connected to more than 5 volts.

MIT310A will show approximately 40% of true voltage.

Additional notes:

Battery Level  = Exhausted battery

Battery test

Battery condition can be checked by rotating the range knob to the battery symbol and pressing TEST button. The position of the needle over the taper symbol will indicate battery condition. Highest charge to the right.

Note: NiMH or NiCAD rechargeable batteries show a lower charge than alkaline batteries, and may not give much warning before becoming exhausted.

Warning: Always perform a battery test prior to using the instrument to ensure the instrument will function properly.

LED Indicators:

Two led indicators show testing status information for test lock and voltage detection

Voltage warning:

If a voltage greater than 50 V exists on the circuit under test and the TEST button is pressed, the RED 'V' LED will light and testing will be automatically inhibited.

Test lead Null (MIT310A only)

Before using the continuity range for the first time, the test lead resistance should be 'zeroed out'. This ensures any measurement does not include the resistance of the test leads.

To null the test leads:

1. Connect the test leads to the instrument and firmly short both leads together.

-
2. Wait for the reading to stabilise and adjust the lead null knob  until the display pointer indicates 0 Ω .
 3. Lead null should be checked periodically and at the start of each session to ensure ZERO is maintained, or adjusted as necessary.

Note: Lead null can remove up to 0.5 Ω of lead resistance.

Continuity test (MIT310A)

Continuity range extends from 0.00 Ω to 2 k Ω .

Ranges are not auto-ranging. Manual selection of each range is necessary.

Test currents are: 200 mA to 2 Ω , 20 mA to 20 Ω , 2 mA to 200 Ω , 200 μ A to 2 k Ω .

To make a continuity measurement:

1. Select the continuity range required.
2. Connect the test leads to the circuit under test.
3. For a single test press and hold down the [TEST] button.
4. Read the resistance from the appropriate range scale.

To increase battery life release it as soon as possible after a test is complete.

Continuity buzzer test

It is best to lock the test button down: press and hold down the test button. Press the lock button momentarily.

Insulation testing

Insulation testing is the same as page 13, however the result is only displayed as long as the [TEST] button is depressed.



Note: If the batteries are exhausted the instrument may not show a needle movement when testing. We recommend an occasional insulation

test should be performed with the leads shorted together or the battery test mode should be selected to ensure the batteries are in good working condition.

MIT310A Test lock

The [TEST] button can be locked down to allow continuous continuity or insulation testing.

To enable the TEST LOCK:

1. Press and hold down the [TEST] button. Press the  button momentarily.
2. The TEST LOCK LED  should light.

To remove TEST LOCK:

1. Press the [TEST or LOCK] button.

The SP4F switch probe allows the user to start a test by pressing the [TEST] button on the probe, instead of the instrument. This allows for complete hands free testing and increases user safety.

To use the SP4F probe:

1. Connect the SP4F probe to the MIT320 or MIT330 using the special 3 pole +ve socket (in place of the RED test lead).
2. Select a suitable insulation test range.
3. Press and hold down the SP4F probe button. The MIT320 or MIT330 will start an insulation test.
4. When the result has settled, release the probe test button.

Storing continuity test results:

Results storage has the following structure:

→ 000, → 002...255 = Job number
b00, b01, b02 ...99 = Distribution board No.
c00, c01, c02...99 = Circuit number
R12, RrN, Rr2, Rr1, R1 & R2 = Circuit type
P1 to P3 = Phase

Job number (→ 000, → 001...) acts as a work folder, allowing a set of results to be saved in one folder.

When downloaded, all results with the same job number can be sorted together, no matter where they occur in the instruments memory.

Distribution board number b01, b02... and circuit reference c00, c01...:

Results can be assigned a specific distribution board number and circuit reference number prior to storing.

R1,R2, R12, Rr1 etc circuit, type allows a test to be defined as the circuit type.

P1, P2 ...Phase number, each test can be stored under a particular phase, P1, P2 or P3.

Unique test number, each test result is assigned a unique test number, from 0 to 1999. This is automatic and cannot be adjusted.

To store a result:

1. Make a continuity measurement as described earlier and press STORE.
2. Select job reference number using ↑↓ keys then press NEXT.

(Hold the key down to scroll quickly through the numbers)

3. Select distribution board number (b01,02 etc) using ↑↓ keys then press NEXT
4. Select circuit number (c01,02 etc) using ↑↓ keys then press NEXT
5. Select the circuit type, R12, RrN, Rr2, Rr1, R2 or R1 by pressing the ↑↓ keys, then press NEXT.
6. Select the phase using ↑↓ keys then press NEXT. The screen will display a unique test number, which is attached to that particular test.
7. Press OK to save the result.

To store a subsequent result:

To save the next test under the same location job number, distribution board, circuit reference etc:

1. Make another measurement as described earlier and press STORE.
2. The last Job number ** will be displayed. Press OK.
3. The unique test number will be displayed. Press OK and the result is stored.

Note: The job number, distribution board, circuit and test type can all be changed before saving a result by selecting the function using the ↑↓ keys.

To recall the last test result:

1. Set the range knob to RCL
2. The last unique test number is displayed
3. Press OK and the test result will be displayed.

Note: Only the last test result can be recalled to the display.

Storing insulation test results:

Storing an insulation test result is exactly the same as a continuity test. However the circuit type options change to L-E, L-L, L-N, N-E

Downloading results to a PC:

1. Connect the tester to the PC using the USB test lead.
2. Set the tester range knob to [Snd].
3. Run Megger Powersuite Professional or Megger Download Manager on the PC
4. Select the appropriate downloading instrument from the list
5. Select "download from tester"
6. The test data will automatically download its contents to the PC.

A bar graph shows the status of the download.

Deleting test results

To delete the latest test result:

1. Set the range knob to [dEL]. The display will flash "dEL" followed by the test number to be deleted.
2. Press the OK button. The last test result will be deleted.

WARNING: This operation is not reversible.

To delete all test data:

1. Set the range knob to [dEL]. The display will flash "dEL".
2. Press the NEXT or LAST key. The display will flash "ALL".
3. Press the OK button. All the test results will be deleted.

A bar graph shows the progress of the deletion.

REPLACING BATTERIES AND FUSES

WARNING: This operation is not reversible. All data will be deleted.



Batteries

Battery type: 8 x LR6 (AA), 1.5 V Alkaline, or 8 x 1.2V NiCAD, or 8 x 1.2V NiMH

Fuse type: 500 mA (F) HBC 50 kA 600 V

Fuse blown symbol 

Low battery warning symbol

The battery condition is continuously displayed by the symbol  .
When the batteries are exhausted, symbol will show 
and testing is inhibited.

Note: Fully charged NiMH or NiCAD rechargeable batteries show a lower charge than alkaline batteries, and may not give much warning before becoming exhausted.

To replace batteries

Warning: Do not switch the instrument on with the battery cover removed.

1. Switch off the instrument and disconnect (the instrument) from any electrical circuits.
2. The rear cover **must not** be opened if the test leads are connected.
3. To avoid the possibility of electric shock, do not press the test button or touch the fuse when changing batteries.
4. To remove the rear cover release the screw at the bottom of the cover and lift the cover upwards.
5. Remove the dead cells.
6. Refit new batteries observing the correct polarity as marked on the battery compartment.
7. Replace the cover.

PREVENTIVE MAINTENANCE

Warning: - Incorrect battery cell polarity can cause electrolyte leakage, resulting in damage to the instrument. If the battery condition indicator does not show a full charge when battery cells are new, a cell may be reversed.

Note: Battery cells should not be left in an instrument which may remain unused for extended periods.

Fuse replacement (user replaceable)

To check fuse, select Ω range.

Short circuit the test leads. If the fuse is good, the display will show approx. 0Ω .

Display of the fuse symbol  indicates a ruptured fuse.

The fuse is located behind the rear cover. The rear cover must not be opened if test leads are connected.

To avoid the possibility of shock, disconnect the battery before touching the fuse.

A replacement fuse must be of the correct type and rating.

Fuse: 500 mA (F) H.B.C. 50 kA min 600 V (32 mm x 6 mm)

The MIT series instruments require very little maintenance.

Test leads should be checked before use to ensure there is no damage.

Ensure batteries are removed if left unused for extended periods.

When necessary, the instrument can be cleaned with a damp cloth.

Do not use alcohol based cleaners as these may leave a residue.

SPECIFICATIONS

Note: For the MIT310A only, the presence of fast transients in excess of 0.5kV or r.f. in excess of 1 volt on measured circuit may affect the results

General Specification

Insulation ranges

Nominal test voltage:

MIT310, 310A, 320, 330 1000 V, 500 V, 250 V (d.c.)

MIT300 250 V, 250 V (d.c.)

Terminal voltage on open circuit (0°C):

-0% +20% of rated voltage

Measuring Range

All instruments:

10 kΩ - 999 MΩ on all ranges

Short circuit current:

1.5 mA nominal

Test current on load:

1 mA at min. pass values of insulation (as specified in BS 7671, HD 384 and IEC 364)

Accuracy (at 20° C)

MIT300, 310, 320, 330: ±3%, ±2 digits up to 10 MΩ, ±5% up to 100 MΩ, ±30% up to full scale

MIT310A: ±2.5% of scale length (or 30% of reading 200 kΩ to 10 MegΩ)

Terminal characteristics

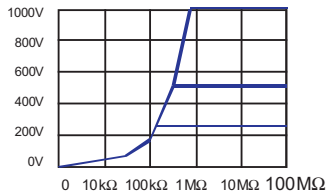

Continuity ranges

Measuring range: 0,01 Ω - 100 Ω
(0 -50 Ω on analogue scale)

Open circuit voltage: 5 V ±1 V

Short circuit current: 205 mA +10 mA -5 mA

Accuracy (at 20° C)

MIT300, 310, 320, 330: ±3% ±2 digits

MIT310A: ±2.5% of scale length
(or 30% of reading 0.2Ω to 2 kΩ)

Zero offset adjust:

MIT300, 310,320, 330: 0 - 9 Ω

MIT310A: 0 - 0.5Ω

Continuity buzzer

MIT300, 310: Operates at <5 Ω

MIT320, 330: Adjustable 1 Ω to 20 Ω

MIT310A: Operates at <5 Ω

MIT300, 310, 320, 330: Response time <20 ms

MIT310A: Response time <100 ms

Resistance range (MIT 320 and MIT330 only)

(can be used for diode testing)

Measuring range: 10 Ω - 1 MΩ

Open circuit voltage: 5 V

Short circuit current: 1.5 mA,

Accuracy (at 20°C): ±5% ±2 digits up to 100 kΩ

Measuring range (MIT310A only): 0 - 2 kΩ (refer to continuity)

Voltage range

Measuring range: 0 - 600 V a.c. (50/60 Hz) or d.c.

Accuracy (at 20° C)

MIT300, 310, 320, 330: d.c. or a.c. (50/60Hz): ±1%,
±2 digits

MIT310A: ±2.5% of scale length for 50/60Hz

Temperature coefficient: <0,1% per °C on all ranges.

Default voltmeter

all test modes except off

MIT310, 320, 330 voltmeter: >25 V a.c. or d.c. is applied display will operate as a voltmeter

M300: Beeps and flash 'V' on the display

M310A: Warning LED lights when [TEST] button is pressed. Operates as voltmeter when test button not pressed

Test inhibit: If more than 50 volts is detected, testing will be inhibited.

Autopower down: Auto power down operates after 10 minutes if left in standby mode.

Environmental

Operating range: -10°C to +60°C

Operating humidity: 93% R.H. at +40°C max.

Storage range: -25°C to +70°C

Environmental protection: IP54

Results storage and downloading

Capacity: > 1000 results

Download: USB download lead 1.8m (supplied)

Download lead: Type A to Type B

Dimensions

All units 203 x 148 x 78 mm

Fuses

Terminals:

500 mA (F) 600 V, 32 x 6 mm ceramic

HBC 50 kA minimum.

Safety

Meets the requirements of IEC61010-1 Cat III 600 V phase to earth. Refer to safety warnings supplied.

Automatic discharge

After an insulation test the item under test will be discharged automatically. Any voltage present will be indicated on the display so that the discharge can be monitored.

Power supply

Battery: 8 x 1,5 V cells IEC LR6 type(AA alkaline).

Rechargeable NiCAD or NiMH cells may be used.

Battery condition is constantly shown on the display as a four-section bar graph.

Battery Life

5000 consecutive tests (5 seconds per test) on any test using 2Ah batteries.

Weight

All units 980gms

E.M.C. In accordance with IEC61326 -1

Operational uncertainties Refer to www.megger.com

ACCESSORIES

	Order Code
Included Accessories	
Test lead set (red & black) with crocodile clips	6220-779
USB download lead (MIT330 only)	25970-041
Download Manager CD	6111-442
Quick start guide	5174-188
CD containing user manual	

Optional Accessories

Fused lead set 2 wire fused probe and clip set	6220-789
SP4F Switch probe (MIT320 and MIT330 only)	6220-809

Megger Certification Software

Powersuite Pro-Lite 16th

REPAIR AND WARRANTY

The instrument contains static sensitive devices, and care must be taken in handling the printed circuit board. If an instrument's protection has been impaired it should not be used, but sent for repair by suitably trained and qualified personnel. The protection is likely to be impaired if, for example, it shows visible damage, fails to perform the intended measurements, has been subjected to prolonged storage under unfavourable conditions, or has been subjected to severe transport stresses.

NEW INSTRUMENTS ARE GUARANTEED FOR 3 YEARS FROM THE DATE OF PURCHASE BY THE USER.

Note: Any unauthorized prior repair or adjustment will automatically invalidate the Warranty.

INSTRUMENT REPAIR AND SPARE PARTS

For service requirements for Megger Instruments **contact:**

Megger Limited	or	Megger
Archcliffe Road		Valley Forge Corporate Centre
Dover		2621 Van Buren Avenue
Kent CT17 9EN		Norristown PA 19403
England.		U.S.A.
Tel: +44 (0) 1304 502 243		Tel: +1 610 676 8579
Fax: +44 (0) 1304 207 342		Fax: +1 610 676 8625

Megger operate fully traceable calibration and repair facilities, ensuring your instrument continues to provide the high standard of performance and workmanship you expect. These facilities are complemented by a worldwide network of approved repair and calibration companies to offer excellent in-service care for your Megger products.

Returning your product to Megger - UK and USA service centres

1. When an instrument requires recalibration, or in the event of a repair being necessary, a Returns Authorisation (RA) number must first be obtained from one of the addresses shown above. You will be asked to provide the following information to enable the Service Department to prepare in advance for receipt of your instrument, and to provide the best possible service to you.
 - Model, e.g. MIT300.
 - Serial number, to be found on the underside of the case or on the calibration certificate.
 - Reason for return, e.g. calibration required, or repair.
 - Details of the fault if the instrument is to be repaired.
2. Make a note of the RA number. A returns label can be emailed or faxed to you if you wish.
3. Pack the instrument carefully to prevent damage in transit.
4. Ensure the returns label is attached, or that the RA number is clearly marked on the outside of the package and on any correspondence, before sending the instrument, freight paid, to Megger. Copies of the original purchase invoice and packing note should be sent simultaneously by airmail to expedite clearance through customs. In the case of instruments requiring repair outside the warranty period, an immediate quotation can be provided when obtaining the RA number.
5. You may track the progress of your return on line at www.megger.com

Approved Service Centres

A list of Approved Service Centres may be obtained from the UK address above, or from Megger's website at www.megger.com



Megger Limited
Archcliffe Road, Dover
Kent CT17 9EN England
T +44 (0)1 304 502101
F +44 (0)1 304 207342
E uksales@megger.com

Megger
4271 Bronze Way, Dallas,
Texas 75237-1019 USA
T +1 800 723 2861 (USA ONLY)
T +1 214 333 3201
F +1 214 331 7399
E ussales@megger.com

Megger
Z.A. Du Buisson de la Couldre
23 rue Eugène Henaff
78190 TRAPPES France
T +33 (0)1 30.16.08.90
F +33 (0)1 34.61.23.77
E infos@megger.com

Megger Pty Limited
Unit 26 9 Hudson Avenue
Castle Hill
Sydney NSW 2125 Australia
T +61 (0)2 9659 2005
F +61 (0)2 9659 2201
E ausales@megger.com

Megger Limited
110 Milner Avenue Unit 1
Scarborough Ontario M1S 3R2
Canada
T +1 416 298 9688 (Canada
only)
T +1 416 298 6770
F +1 416 298 0848
E casales@megger.com

Megger products are distributed in 146 countries worldwide.

**This instrument is manufactured in the United Kingdom.
The company reserves the right to change the specification or design without prior notice.**

Megger is a registered trademark

Part No. 6172-877 V11 0109
www.megger.com