

381

Remote Display True-rms Clamp Meter

Calibration Manual

LIMITED WARRANTY AND LIMITATION OF LIABILITY

Each Fluke product is warranted to be free from defects in material and workmanship under normal use and service. The warranty period is three years and begins on the date of shipment. Parts, product repairs, and services are warranted for 90 days. This warranty extends only to the original buyer or end-user customer of a Fluke authorized reseller, and does not apply to fuses, disposable batteries, or to any product which, in Fluke's opinion, has been misused, altered, neglected, contaminated, or damaged by accident or abnormal conditions of operation or handling. Fluke warrants that software will operate substantially in accordance with its functional specifications for 90 days and that it has been properly recorded on non-defective media. Fluke does not warrant that software will be error free or operate without interruption.

Fluke authorized resellers shall extend this warranty on new and unused products to end-user customers only but have no authority to extend a greater or different warranty on behalf of Fluke. Warranty support is available only if product is purchased through a Fluke authorized sales outlet or Buyer has paid the applicable international price. Fluke reserves the right to invoice Buyer for importation costs of repair/replacement parts when product purchased in one country is submitted for repair in another country.

Fluke's warranty obligation is limited, at Fluke's option, to refund of the purchase price, free of charge repair, or replacement of a defective product which is returned to a Fluke authorized service center within the warranty period.

To obtain warranty service, contact your nearest Fluke authorized service center to obtain return authorization information, then send the product to that service center, with a description of the difficulty, postage and insurance prepaid (FOB Destination). Fluke assumes no risk for damage in transit. Following warranty repair, the product will be returned to Buyer, transportation prepaid (FOB Destination). If Fluke determines that failure was caused by neglect, misuse, contamination, alteration, accident, or abnormal condition of operation or handling, including overvoltage failures caused by use outside the product's specified rating, or normal wear and tear of mechanical components, Fluke will provide an estimate of repair costs and obtain authorization before commencing the work. Following repair, the product will be returned to the Buyer transportation prepaid and the Buyer will be billed for the repair and return transportation charges (FOB Shipping Point).

THIS WARRANTY IS BUYER'S SOLE AND EXCLUSIVE REMEDY AND IS IN LIEU OF ALL OTHER WARRANTIES, EXPRESS OR IMPLIED, INCLUDING BUT NOT LIMITED TO ANY IMPLIED WARRANTY OF MERCHANTABILITY OR FITNESS FOR A PARTICULAR PURPOSE. FLUKE SHALL NOT BE LIABLE FOR ANY SPECIAL, INDIRECT, INCIDENTAL OR CONSEQUENTIAL DAMAGES OR LOSSES, INCLUDING LOSS OF DATA, ARISING FROM ANY CAUSE OR THEORY.

Since some countries or states do not allow limitation of the term of an implied warranty, or exclusion or limitation of incidental or consequential damages, the limitations and exclusions of this warranty may not apply to every buyer. If any provision of this Warranty is held invalid or unenforceable by a court or other decision-maker of competent jurisdiction, such holding will not affect the validity or enforceability of any other provision.

Fluke Corporation
P.O. Box 9090
Everett, WA 98206-9090
U.S.A.

Fluke Europe B.V.
P.O. Box 1186
5602 BD Eindhoven
The Netherlands

11/99

To register your product online, visit register.fluke.com

Table of Contents

Title	Page
Introduction.....	1
Contact Fluke.....	1
Safety Information.....	2
The Meter.....	5
Specifications.....	5
Electrical Specifications.....	5
Mechanical Specifications.....	7
Environmental Specifications.....	7
Performance Tests.....	8
Calibration Adjustment.....	10
Required Equipment.....	10
Calibration Password Operation Procedure.....	10
Change the Password.....	11
Two Special Passwords.....	11
Adjustment Procedure.....	11
Balance Adjustment.....	12
Maintenance.....	14
Clean the Product.....	14
Battery Replacement.....	14
User Replaceable Parts.....	15

List of Tables

Table	Title	Page
1.	Symbols.....	4
2.	Performance Tests.....	8
3.	Flexible Current Probe Performance Tests	10
4.	Required Equipment.....	10
5.	Adjustment Procedure.....	13
6.	User Replaceable Parts.....	15

List of Figures

Figure	Title	Page
1.	The Meter	5
2.	Position Sensitivity.....	6
3.	Changing the Batteries	15

Introduction

Warning

Read "Safety Information" before you use the Product.

This manual explains the Calibration Adjustment for the 381 Remote Display True-rms Clamp Meter (the Product). Please see the *381 Users Manual* for usage information. The Product is a handheld, battery-operated Clamp Meter that has a remote-display module and detachable iFlex (Flexible Current Probe).

Contact Fluke

To contact Fluke, call one of the following telephone numbers:

- Technical Support USA: 1-800-44-FLUKE (1-800-443-5853)
- Calibration/Repair USA: 1-888-99-FLUKE (1-888-993-5853)
- Canada: 1-800-36-FLUKE (1-800-363-5853)
- Europe: +31 402-675-200
- Japan: +81-3-3434-0181
- Singapore: +65-738-5655
- China: +86-400-810-3435
- Anywhere in the world: +1-425-446-5500

Or, visit Fluke's website at www.fluke.com.

To register your product, visit <http://register.fluke.com>.

To see, print, or download the latest manual supplement, visit <http://us.fluke.com/usen/support/manuals>.



Safety Information

A **Warning** identifies conditions and actions that pose hazard(s) to the user. A **Caution** identifies conditions and procedures that could cause Meter damage, equipment under test damage, or permanent loss of data.

Symbols used on the Product and in this manual are explained in Table 1.

Warning

To prevent possible electrical shock, fire, or personal injury:

- Use the product only as specified, or the protection supplied by the Product can be compromised.
- Examine the case before you use the Product. Look for cracks or missing plastic. Carefully look at the insulation around the terminals.
- Do not measure current while the test leads are in the input jacks.
- The battery door must be closed and locked before you operate the Product.
- Remove all probes, test leads, and accessories before the battery door is opened.
- Do not use test leads if they are damaged. Examine the test leads for damaged insulation, exposed metal, or if the wear indicator shows. Check test lead continuity.
- Do not use the Product if it operates incorrectly.
- Do not use the Product around explosive gas, vapor, or in damp or wet environments.
- Use only type AAA batteries, properly installed in the Product case, to power the Product.
- Hold the Product behind the tactile barrier. See Figure 1.
- Replace the batteries when the low battery indicator (meter  or remote ) shows to prevent incorrect measurements.
- Use only specified replacement parts.
- Have an approved technician repair the product.
- Do not touch voltages >30 V ac rms, 42 V ac peak, or 60 V dc.
- Do not apply more than the rated voltage, between the terminals or between each terminal and earth ground.
- Keep fingers behind the finger guards on the probes.
- Connect the common test lead before the live test lead and remove the live test lead before the common test lead.
- Do not work alone.

- Use caution around bare conductors or bus bars. To prevent electrical shock, do not touch the conductor.
- Comply with local and national safety codes. Use personal protective equipment (approved rubber gloves, face protection, and flame-resistant clothes) to prevent shock and arc blast injury where hazardous live conductors are exposed.
- Disconnect power and discharge all high-voltage capacitors before you measure resistance or continuity.
- Do not measure ac/dc current in circuits carrying more than 600 V or 200 A with the Product Jaw.
- Do not operate the product with covers removed or the case open. Hazardous voltage exposure is possible.
- When white wear indicator insulation shows through the clamp cable jacket, replace the clamp cable.
- When batteries are changed, ensure that the calibration seal in the battery compartment is not damaged. If damaged, the Product may not be safe for use. Return the Product to Fluke for replacement of the seal.
- Do not exceed the Measurement Category (CAT) rating of the lowest rated individual component of a product, probe, or accessory.
- Do not measure ac current in circuits carrying more than 1000 V or 2500 A with the Flexible Current Probe.
- Do not apply the Flexible Current Probe around or remove from HAZARDOUS LIVE conductors.
- Take special care during fitting and removal of the Flexible Current Probe. De-energize the installation under test or wear suitable protective clothing.

⚠ Caution

To prevent possible damage to the product or to equipment under test:

- Use the correct terminals, function, and range for measurements.
- Clean the case and accessories with a damp cloth and mild detergent only. Do not use abrasives or solvents.

Table 1. Symbols

Symbol	Meaning	Symbol	Meaning
	AC (Alternating Current)		Earth ground
	DC (Direct Current)		AC and dc current.
	Hazardous voltage		Conforms to European Union directives.
	Risk of Danger. Important information. See Manual.		Conforms to relevant North American Safety Standards.
	Battery. Low battery when shown.		Double insulated
CAT III	IEC Measurement Category III CAT III equipment has protection against transients in equipment in fixed-equipment installations, such as distribution panels, feeders and short branch circuits, and lighting systems in large buildings.	CAT IV	IEC Measurement Category IV CAT IV equipment has protection against transients from the primary supply level, such as an electricity Meter or an overhead or underground utility service.
	Examined and licensed by TÜV Product Services.		Conforms to relevant Australian standards.
	Do not apply to or remove from HAZARDOUS LIVE conductors.		Application around and removal from HAZARDOUS LIVE conductors is permitted.
	Do not dispose of this product as unsorted municipal waste. Go to Fluke's website for recycling information.		

Note

The Measurement Category (CAT) and voltage rating of any combination of test probe, test probe accessory, current clamp accessory, and the Meter is the LOWEST rating of any individual component.

The Meter

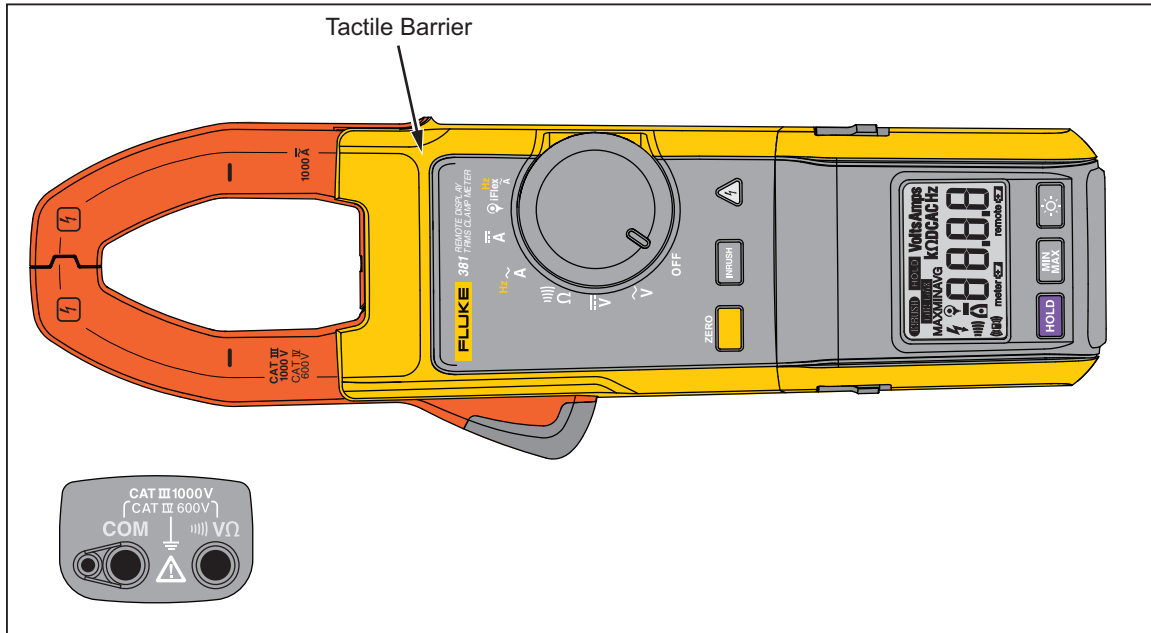

Figure 1. The Meter

ghn02.eps

Specifications

Electrical Specifications

AC Current Via Jaw

Range	999.9 A
Resolution	0.1 A
Accuracy	2 % ± 5 digits (10-100 Hz)
	5 % ± 5 digits (100-500 Hz)
Crest Factor (50/60 Hz)	3 @ 500 A
	2.5 @ 600 A
	1.42 @ 1000 A
	Add 2 % for C.F. > 2

AC Current via Flexible Current Probe

Range	999.9 A / 2500 A (45 Hz – 500 Hz)
Resolution	0.1 A / 1 A
Accuracy	3 % ± 5 digits
Crest Factor (50/60Hz)	3.0 at 1100 A
	2.5 at 1400 A
	1.42 at 2500 A
	Add 2 % for C.F. > 2

Position Sensitivity

Figure 2 shows the position sensitivity of the Flexible Current Probe.

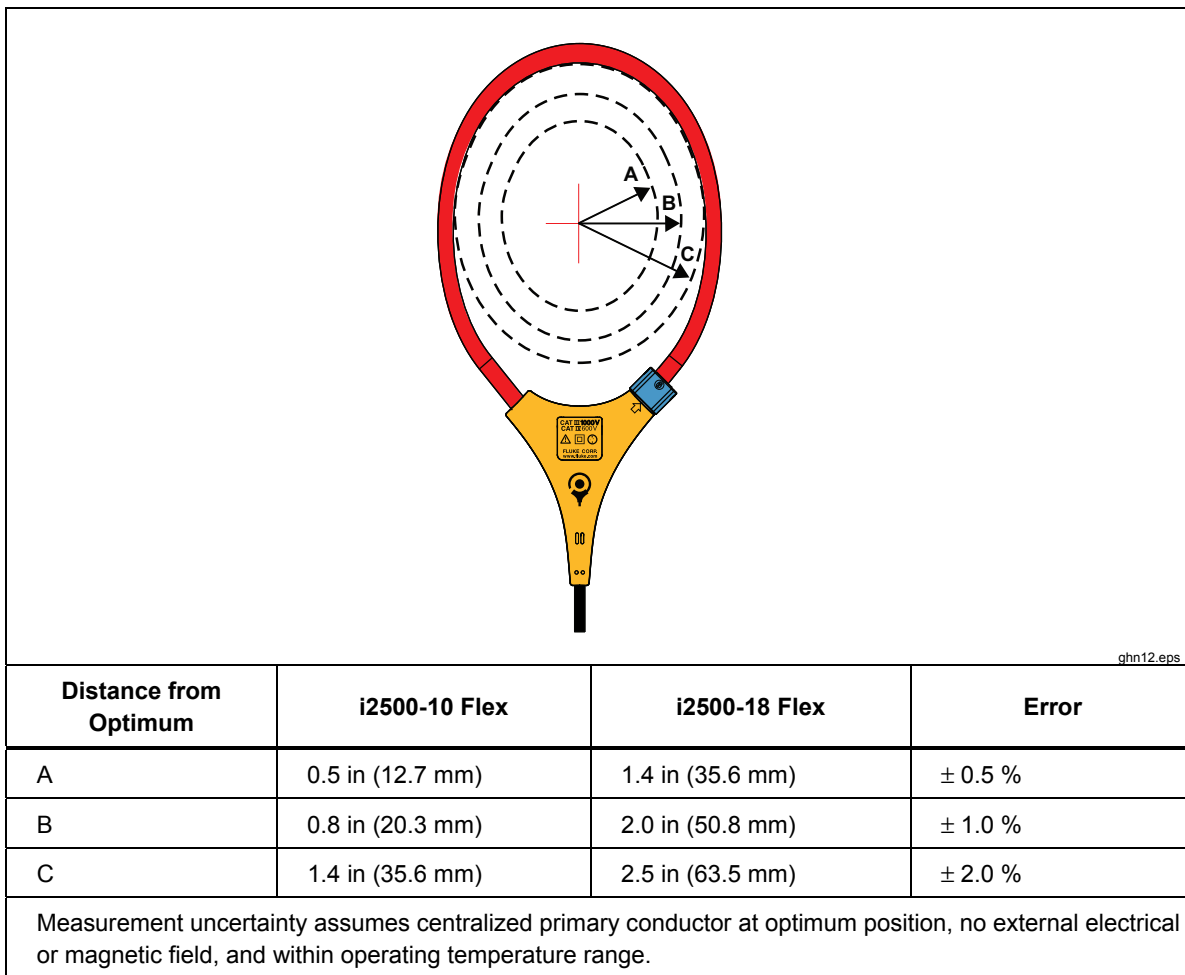

Figure 2. Position Sensitivity

DC Current

Range 999.9 A
 Resolution 0.1 A
 Accuracy 2 % ± 5 digits

AC Voltage

Range 600 V / 1000 V
 Resolution 0.1 V / 1 V
 Accuracy 1.5 % ± 5 digits (20 – 500 Hz)

DC Voltage

Range 600.0 V / 1000 V
 Resolution 0.1 V / 1 V
 Accuracy 1 % ± 5 digits

Frequency – Via Jaw

Range 5.0 – 500.0 Hz
 Resolution 0.1 Hz
 Accuracy 0.5 % ± 5 digits

Trigger Level 5 – 10 Hz, ≥10 A
10 – 100 Hz, ≥5 A
100 – 500 Hz, ≥10 A

Frequency via Flexible Current Probe

Range 5.0 to 500.0 Hz
Resolution 0.1 Hz
Accuracy 0.5 % ± 5 digits
Trigger Level 5 to 20 Hz, ≥ 25 A
20 to 100 Hz, ≥ 20 A
100 to 500 Hz, ≥ 25 A

Resistance

Range 600 Ω/6 kΩ/60 kΩ
Resolution 0.1 Ω/1 Ω/10 Ω
Accuracy 1 % ± 5 digits

Mechanical Specifications

Size (L x W x H) 277 mm *88 mm * 43 mm (55 mm for remote unit)
Weight..... 350 g
Jaw Opening 34 mm
Flexible Current Probe Diameter 7.5 mm
Flexible Current Probe Cable Length
(head to electronics connector) 1.8 m

Environmental Specifications

Operating Temperature..... -10 °C to +50 °C
Storage Temperature..... -40 °C to +60 °C
Operating Humidity Non condensing (< 10 °C)
≤ 90 % RH (at 10 °C to 30 °C)
≤ 75 % RH (at 30 °C to 40 °C)
≤ 45 % RH (at 40 °C to 50 °C)
(Without Condensation)
Operating Altitude 2000 meters
Storage Altitude 12,000 meters
EMI, RFI, EMC, RF EN 61326-1:2006, EN 61326-2-2:2006
ETSI EN 300 328 V1.7.1:2006
ETSI EN 300 489 V1.8.1:2008
FCC Part 15 Subpart C Sections 15.207, 15.209, 15.249 FCCID: T68-F381
RSS-210 IC: 6627A-F381
Temperature Coefficients..... Add 0.1 x specified accuracy for each degree C above
28 °C or below 18 °C
Wireless Frequency 2.4 GHz ISM Band 10 meter range
Safety Compliance..... ANSI/ISA S82.02.01:2004
CAN/CSA-C22.2 No. 61010-1-04
IEC/EN 61010-1:2001 to 1000V CAT III, 600V CAT IV.
Double Insulation Clearance..... Per IEC 61010-2-032
Double Insulation Creepage Per IEC 61010-1
Agency Approvals 

Performance Tests

⚠️⚠️ Warning

To prevent possible electrical shock, fire, or personal injury, do not perform the performance test procedures unless the Product is fully assembled.

The following performance tests verify the complete operation of the Product and check the accuracy of each function against the Product's specifications. See Table 2. If the Product fails any part of the test, calibration adjustment and/or repair is indicated. See "Calibration Adjustment". Table 2 shows the Performance tests for the product. Table 3 shows the Performance tests for the Flexible Current Probe.

Table 2. Performance Tests



Test (Switch Position)	Calibrator Output Value	Res.	Spec.	Cnts.	Err.	UUT Meter Reading Limit		UUT
						Low	High	
 AC Volts	20 V, 20 Hz	0.1	1.5 %	5	0.4	19.6	20.4	
	10 V, 50 Hz	0.1	1.5 %	5	0.3	9.7	10.3	
	600 V	0.1	1.5 %	5	4.8	595.3	604.8	
	1000 V	1	1.5 %	5	10.0	990	1010	
	10 V, 500 Hz	0.1	1.5 %	5	0.3	9.7	10.3	
	600 V, 500 Hz	0.1	1.5 %	5	4.8	595.3	604.8	
	1000 V, 500 Hz	1	1.5 %	5	10.0	990	1010	
 DC Volts	-1000 V, 0 Hz	1	1.0 %	5	7.5	-1008	-993	
	-600 V, 0 Hz	0.1	1.0 %	5	3.3	-603.3	-596.8	
	-10 V, 0 Hz	0.1	1.0 %	5	0.3	-10.3	-9.7	
	10 V, 0 Hz	0.1	1.0 %	5	0.3	9.7	10.3	
	600 V, 0 Hz	0.1	1.0 %	5	3.3	596.8	603.3	
	1000 V, 0 Hz	1	1.0 %	5	7.5	993	1008	
 Ohms	0 Ω	0.1	1.0 %	5	0.3	-0.3	0.3	
	10 Ω	0.1	1.0 %	5	0.3	9.7	10.3	
	100 Ω	0.1	1.0 %	5	0.8	99.3	100.8	
	590 Ω	0.1	1.0 %	5	3.2	586.8	593.2	
	1000 Ω	1	1.0 %	5	7.5	993	1008	
	3000 Ω	1	1.0 %	5	17.5	2983	3018	
	6000 Ω	1	1.0 %	5	32.5	5968	6033	
	10 k Ω	0.01	1.0 %	5	0.1	9.93	10.08	
	30 k Ω	0.01	1.0 %	5	0.2	29.83	30.18	
	60 k Ω	0.01	1.0 %	5	0.3	59.68	60.33	

Table 2. Performance Tests (cont.)

Test (Switch Position)	Calibrator Output Value	Res.	Spec.	Cnts.	Err.	UUT Meter Reading Limit		UUT
						Low	High	
$\text{Hz} \sim$ A AC Amps (with 50- Turn Coil)	2 A, 10 Hz	0.1	2.0 %	5	1.3	98.8	101.3	
	0.2 A, 50 Hz	0.1	2.0 %	5	0.4	9.7	10.4	
	2 A, 50 Hz	0.1	2.0 %	5	1.3	98.8	101.3	
	12 A, 50 Hz	0.1	2.0 %	5	6.3	593.8	606.3	
	18 A, 50 Hz	0.1	2.0 %	5	9.3	890.8	909.3	
	19.5 A, 50 Hz	0.1	2.0 %	5	10.0	965.0	985.0	
	0.2 A, 500 Hz	0.1	5.0 %	5	0.5	9.5	10.5	
$\overline{\text{A}}$ DC Amps (with 50- Turn Coil)	-19.5 A, 0 Hz	0.1	2.0 %	5	10.0	-985.0	-965.0	
	-12 A, 0 Hz	0.1	2.0 %	5	6.3	-606.3	-593.8	
	-2 A, 0 Hz	0.1	2.0 %	5	1.3	-101.3	-98.8	
	-0.2 A, 0 Hz	0.1	2.0 %	5	0.4	-10.4	-9.7	
	0 A, 0 Hz	0.1	2.0 %	5	0.3	-0.3	0.3	
	0.2 A, 0 Hz	0.1	2.0 %	5	0.4	9.7	10.4	
	2 A, 0 Hz	0.1	2.0 %	5	1.3	98.8	101.3	
	12 A, 0 Hz	0.1	2.0 %	5	6.3	593.8	606.3	
	18 A, 0 Hz	0.1	2.0 %	5	9.3	890.8	909.3	
	19.5 A, 0 Hz	0.1	2.0 %	5	10.0	965.0	985.0	
$\text{Hz} \sim$ A Frequency (with 50- Turn Coil)	0.1 A, 50 Hz	0.1	0.5 %	5	0.4	49.6	50.4	

Performance tests for the Flexible Current Probe are in Table 3. Connect the 5520A A ac output to the 50-turn coil.

Table 3. Flexible Current Probe Performance Tests

Test (Switch Position)	Calibrator Output Value	Res.	Spec.	Cnts.	Err.	UUT Meter Reading Limit		UUT
						Low	High	
AAC/R-coil	0.2 A, 50 Hz ^[1]	0.1	3.0 %	5	0.4	9.6	10.4	
	12 A, 50 Hz ^[1]	0.1	3.0 %	5	9.3	590.8	609.3	
	19.9 A, 50 Hz ^[1]	0.1	3.0 %	5	15.2	979.8	1010.2	
	75 mV, 50 Hz ^[2]	1	3.0 %	5	37.8	2462	2538	
	0.2 A, 500 Hz ^[1]	0.1	3.0 %	5	0.4	9.6	10.4	
	750 mV, 500 Hz ^[2]	1	3.0 %	5	37.8	2462	2538	
Freq./R-coil	50 Hz, 0.4 A ^[1]	0.1	0.5 %	5	0.4	49.6	50.4	
<p>[1] To 50-Turn Coil [2] Simulated by voltage</p>								

Calibration Adjustment

Required Equipment

The equipment listed in Table 4 is required for calibration adjustment.

Table 4. Required Equipment

Equipment	Required Characteristics	Recommended Model
Calibrator	4.5 digit resolution	Fluke 55xxA Calibrator
Wired coil	50 turns	

Calibration Password Operation Procedure

A password is required to access the Calibration adjustment section of the Product. This section explains how this functionality works. To enter a password:

1. Push **HOLD** and turn the rotary switch to $\text{Hz} \sim \text{A}$. The display shows “CAL”.
2. Push **INRUSH** to enter the password entry mode. The display shows “????”.
3. Enter the 4-digit password. For this step, the keys are mapped to the corresponding digits:







HOLD - 1

**MIN
MAX** - 2

⊙ - 3

ZERO
[] - 4

INRUSH - 5

- If you enter a incorrect password, push  or . The display shows “????” and you can re-enter the password.
 - If you enter the correct password, push  to continue calibration (step 5) or push  to change the password. See Change the Password.
4. Push  to enter calibration mode.
 5. Once the Product has entered calibration mode, push  to show the calibration step number. Push  to confirm a calibration value.

Change the Password

To change the password:

1. The display shows “----“.
2. Enter the 4-digit password. For this step, the keys are mapped to the corresponding digits:

 - 1

 - 2

 - 3

 - 4

 - 5

After all 4 digits are entered, the leading “-“ icon appears on the display.

3. Push  to store the new password.
4. After the new password is entered, the Product reboots and the display briefly shows “**F381**” and then changes to the current selected function.

At any step during this procedure, turning rotary switch to OFF terminates the Calibration Password mode.



Two Special Passwords

The Default Password is **1234**. It is used when the Product shows “**CAL ERR**”, which means that the calibration parameter is corrupted. Entering the default password takes you to the calibration mode. After the Product is calibrated, “**CAL ERR**” disappears.

The Master Password is **4132**. If the password is forgotten, you can enter the Master Password after “????” shows on the display. Then push  and the password is restored to the Default Password: **1234**. The Master Password is protected, and you cannot change the Calibration Password to this combination.

Adjustment Procedure

The Product features a closed-case calibration procedure. To adjust Product calibration:

1. Turn the Product ON.
2. Push  while turning the Rotary Switch to $\text{Hz} \sim \text{A}$.
3. Push .
4. Enter the Calibration Password.
5. Push  again to enter calibration mode.



6. Turn the Rotary Switch to the function you wish to calibrate. If you wish to adjust Jaw balance, see Balance Adjustment.
7. Push .
8. See Table 5 and apply the required inputs.
9. Push to confirm the value and move the next calibration point.
10. When you are finished with the calibration adjustment, push and then push to confirm the change.

If you enter the calibration mode but do not wish to save the data, simply turn the Product OFF.

Balance Adjustment

1. Push to enter the balance calibration mode. The display show “**up**”.
2. Place the upper part of jaw close to coil.
3. Wait for the reading to settle.
4. Push to record the reading. The display shows “**don**”.
5. Place the lower part of jaw close to coil.
6. Wait for the reading to settle.
7. Push to record the reading.
8. Repeat these steps, until the display shows “**End**”.
9. Push to exit balance adjustment.

Table 5. Adjustment Procedure

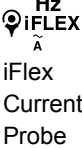
Test (Switch Position)	Product LCD Reading	Action
 DC Volts	C-01	0 Vdc
	C-02	1000 Vdc
 AC Volts	C-03	600 V, 60 Hz
	C-04	600 V, 150 Hz
	C-05	600 V, 250 Hz
	C-06	600 V, 350 Hz
	C-07	600 V, 440 Hz
 Ohms	C-08	10 Ω
	C-09	400 Ω
	C-10	1 K Ω
	C-11	6 K Ω
	C-12	10 K Ω
	C-13	25 K Ω
	C-14	45 K Ω
	C-15	60 K Ω
 AC Amps With 50-turn Coil	C-16	BALANCE (3 A, 60 Hz JAW A ac)
	C-17	TEMPERATURE
	C-18	12 A, 60 Hz JAW A ac
	C-19	3 A, 60 Hz JAW A ac
	C-20	3 A, 150 Hz JAW A ac
	C-21	3 A, 250 Hz JAW A ac
	C-22	3 A, 350 Hz JAW A ac
	C-23	3 A, 440 Hz JAW A ac
 DC Amps With 50-turn Coil	C-24	0 A JAW A dc
	C-25	12 A , 0 Hz JAW A dc
 iFlex Current Probe	C-26	21.6 mV, 60 Hz; Simulates 600 A, 60 Hz ROGO A ac
	C-27	5.4 mV, 150 Hz; Simulates 150 A, 60 Hz ROGO A ac
	C-28	13.5 mV, 150 Hz; Simulates 150 A, 150 Hz ROGO A ac
	C-29	22.5 mV, 250 Hz; Simulates 150 A, 250 Hz ROGO A ac
	C-30	31.5 mV, 350 Hz Simulates 150 A, 350 Hz ROGO A ac
	C-31	39.69 mV, 440 Hz; Simulates 150 A, 440 Hz ROGO A ac

Maintenance

Clean the Product



⚠ Caution

To prevent possible damage to the Product or to equipment under test, do not use abrasive cleaners. They will damage the case.

To clean the Product, use a cloth with a mild cleaning solution.

Battery Replacement

⚠⚠ Warning

To prevent possible explosion, fire, or personal injury, Replace the batteries when the low battery indicator (meter  or remote ) shows to prevent incorrect measurements.

⚠ Caution

To prevent possible damage to the Product or to equipment under test:

- Remove batteries to prevent battery leakage and damage to the Product if it is not used for an extended period.
- Be sure that the battery polarity is correct to prevent battery leakage.

To change the batteries, see Figure 3:

1. Make sure the Product is OFF.
2. Turn the Product over to access the battery compartment door screw.
3. Use a flat-head screwdriver to loosen the battery compartment door screw and lift off the battery compartment door.
4. Replace the three AA batteries.
5. Reattach the battery compartment door.
6. Tighten the battery compartment door screw.

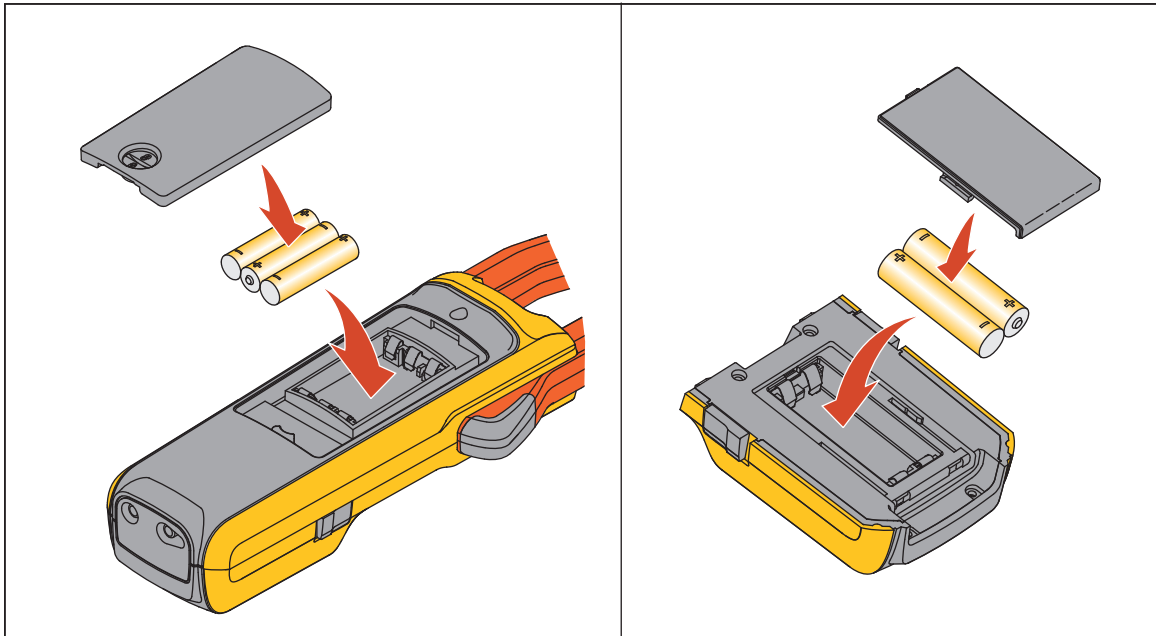

Figure 3. Changing the Batteries

ghn03.eps

User Replaceable Parts

User replaceable parts are listed in Table 6.

Table 6. User Replaceable Parts

Fluke Part Number	Description	Qty
2838018	Battery, AAA 1.5V	5
3625529	Battery Door - Display Module	1
3766406	Battery Door - Main Base	1
3766445	Remote Display	1
3752973	Soft Case	1
3538357	User Manual	1
3782019	TL175 test leads	1
3798105	Fluke I2500-18 Rogowski coil	1
1670641	Alligator, 2 mm jack, red boot	1
1670652	Alligator, 2 mm jack, black boot	1

